

SimMan

Essential

User Guide

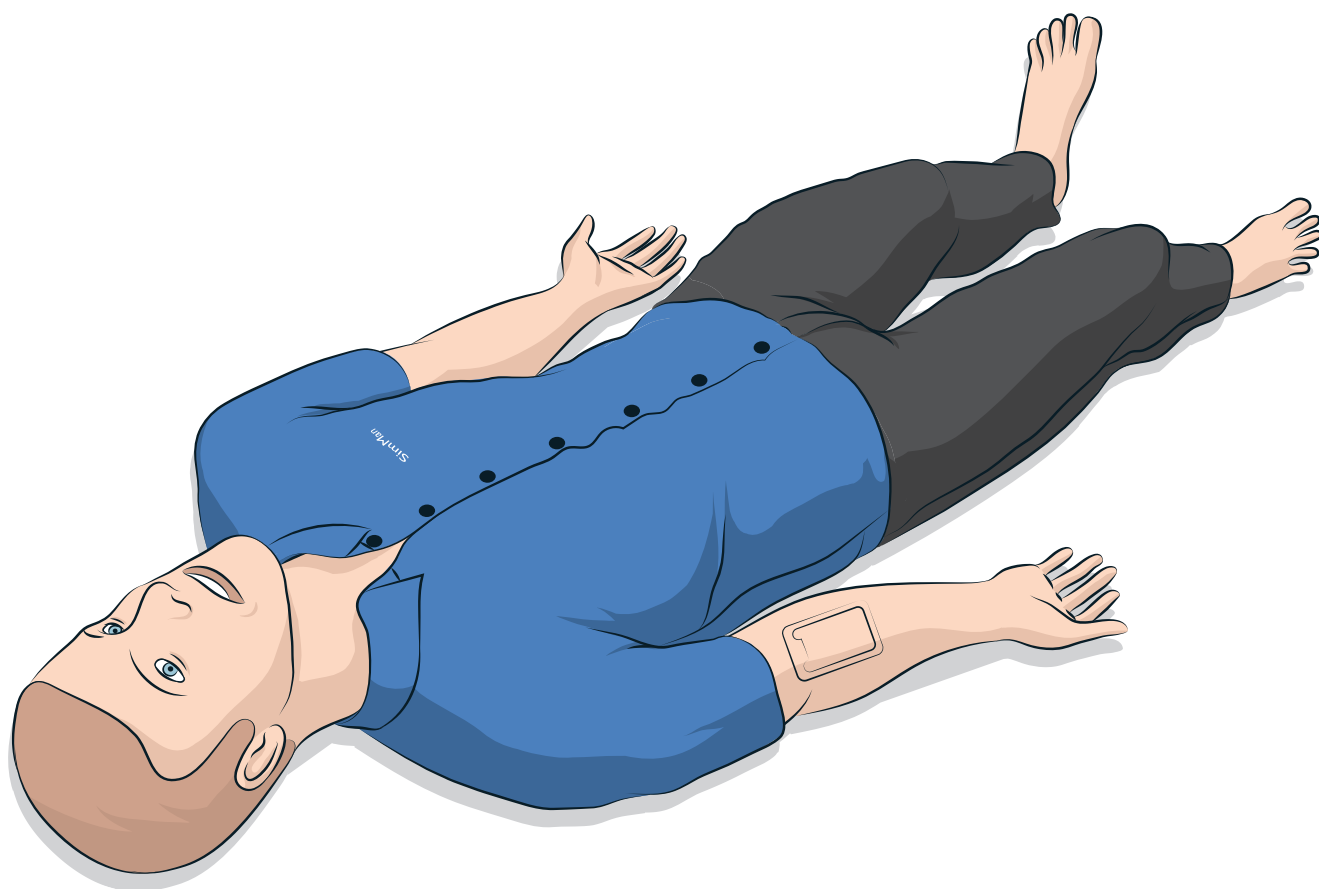

CONTENTS

INTRODUCTION	4	MAINTENANCE	26
SimMan Essential Patient Simulator	4	Daily Maintenance	26
CAUTIONS AND WARNINGS	5	Before Storage or Shipping	26
General Simulator Handling	5	Regular Cleaning of Fluid System	26
Antivirus and Firewalls	5	Regular Cleaning of the IV Arm	27
File Security and Backup of Data	5	Installing and Upgrading LLEAP	27
FEATURES	6	Removing/Changing Router	28
SimMan Essential Overview	6	Opening the Torso	28
General	7	Attaching the Left Leg	29
Laerdal Simulation Software	7	Attaching the Right Leg	29
Airway Features	8	Attaching the Left Arm	30
Breathing Features	9	Attaching the Right Arm	30
Circulation	10	Replacing Crico Tape / Neck Skin	31
Sounds	11	Replacing Chest Drain Pleura	31
Eyes Settings and Configurations	11	Replacing Pneumothorax Bladders	32
Drugs and IV	11	Replacing Chest Rise Bladder	32
SimMan Essential Clothing	11	Replacing Lung Bladders	33
SETUP	12	Replacing Simulator Skins	33
Inserting and Connecting the Batteries	12	Servicing the Patient Simulator	34
The Power Panel	13	TROUBLESHOOTING	35
Charging the Batteries	13	SPARE PARTS AND ACCESSORIES	39
Battery Use	14		
Battery Warnings	15		
Using the Internal Compressor	15		
Turning the Internal Compressor OFF Using LLEAP	15		
Changing Default Compressor Settings Using LLEAP	15		
Air/CO ₂ Panel	16		
The IV Arm	16		
Essential Right Leg Fill Panel	19		
Connecting Defibrillation Adapter Plates	20		
Connecting the Blood Pressure Cuff	21		
Calibrating the Blood Pressure Cuff Using LLEAP	21		
Connecting the SpO ₂ Probe	21		
Changing Genitalia Modules	22		
Changing the Upper Dentures	22		
Changing the Irises	22		
Replacing and Filling Tibial IO Unit with Blood	23		
Transporting SimMan Essential	25		
Unpacking the Patient Simulator	25		

SimMan Essential Patient Simulator

For Clinical Simulation

SimMan Essential is a patient simulation system that facilitates training of Basic and Advanced Life Support. This system allows the instructor to effectively assess the learner's individual and team skills based on realistic clinical situations.

SimMan Essential allows observation and recognition of most vital signs. This is achieved through direct interaction with the Patient Simulator and observation of the Patient Simulator's status which can also be viewed on the Patient Monitor PC (optional).

The SimMan Essential Simulation System Features Include:

- An advanced configurable airway - allowing simulation of difficult airway management cases.
- Eyes with interchangeable pupils and adjustable blinking function.
- Focus on Quality CPR (QCPR): measurement and feedback according to the 2015 Guidelines.
- Vascular Access (intra osseous) via the left tibia.
- Internal urine bladder which can be filled with fluid to simulate urine.
- Automatic Simulation Control based on preprogrammed and validated Patient Cases.

The Main Components of the SimMan Essential

SimMan Essential is an adult life-size wireless Patient Simulator, with internal battery power, internal air compressor and fluid reservoirs. Interventions by learners are registered by the system in the session log, and used for later debriefing.

The Instructor PC controls the simulation. The headset allows the instructor to simulate interactive voice communication between the patient and the learner.

Software available for use with the simulator includes LLEAP for controlling scenarios, SimDesigner for creating and editing scenarios, SimView server or SessionViewer for debriefing simulation sessions with video capture and a Patient Monitor application.

WLAN Communication

Communication between the SimMan Essential Patient Simulator and the PCs is based on WLAN communication. The Patient Simulator and PCs can also be connected to a LAN cable network, and WLAN disabled.

General Simulator Handling

The SimMan Essential Patient Simulator should be operated by trained personnel only. Treat the SimMan Essential Patient Simulator as you would treat a real patient.

 **Warning:** Do not provide artificial respiration to the Patient Simulator using oxygen enriched air or flammable gases.

- Do not introduce fluids into or onto the Patient Simulator (except as directed in the User Guide), as this may damage the Patient Simulator and its components.
- Do not introduce humidified air into the system during ventilation.
- Never perform mouth-to-mouth or mouth-to-nose rescue breathing on the Patient Simulator. The simulator's airways are not designed for cleaning or disinfection.
- Do not use the Patient Simulator if the internal tubing and cabling is disconnected.
- Never use the Patient Simulator outdoors in wet conditions, as this may pose a shock hazard or damage the simulator.
- Never use the Patient Simulator in temperatures exceeding 40° C (104°F), as this may cause overheating and shut down.
- Never use the Patient Simulator in temperatures below 4 °C (39 °F), as this may damage the fluid system.
- The Patient Simulator should never be stored in temperatures below -15° C (5° F).
- The Patient Simulator will automatically shut down if the battery temperature exceeds 60°C (140°F).
- Using a defibrillator in temperatures over 35° C (95° F) may cause overheating and shut down.

 **Warning:** Avoid pinch hazards - Do not remove protective bushings from the Patient Simulator's joints or use it without the external skins.

 **Warning:** Avoid all sharp edges on the Patient Simulator to prevent personal injury.

 **Do not use the SimMan Essential Patient Simulator if:**

- Limbs are not attached to the torso.
- Skins are torn or not properly fastened.
- Internal or external cables, tubes or connectors are damaged.
- There is fluid leakage inside the Patient Simulator torso.
- There are unusual sounds indicating air leakage or mechanical damage.
- There are signs of electrical malfunction, such as an unresponsive Patient Simulator or unusual smell or smoke.

Hygiene

- To maintain Patient Simulator skins, wash hands before use and place the Patient Simulator on a clean surface.
- Wear gloves as required during simulation scenarios.
- After using the Fluid and Blood System, follow the cleaning instructions (see *Maintenance*).
- After using the SimMan Essential Wound Kit, remove glue residue from the Patient Simulator skin with Laerdal Medical Wipes.
- Use only Laerdal Airway Lubricant in the Patient Simulator's airway. Do not spray airway lubricant into the Patient Simulator. Lubricate tools only.

Prevent Stains on Patient Simulator Skins

Avoid using colored plastic gloves, as they may cause discoloration of the Patient Simulator skin.

Do not use felt-tipped markers, ink pens, acetone, iodine or other staining medications near the Patient Simulator. Take care not to place the Patient Simulator on newsprint or colored paper. All staining may be permanent.

Transportation and Storage

SimMan Essential is heavy; ensure that the Patient Simulator is properly secured during transportation to prevent personal injury or damage to the product.

Antivirus and Firewalls

The SimMan Essential Patient Simulator and PCs are not supplied with Antivirus programs. Windows firewall is activated by default. It is the customer's responsibility to protect the simulation system components from unauthorized access.

The Patient Simulator will revert to factory settings each time the power is switched off.

The customer should install all recommended Windows updates from Microsoft. General security measures should be taken before browsing the internet.

It is recommended that the SimMan Essential PCs are used only as Patient Simulator controllers. Downloading other Software programs onto these machines may introduce unexpected errors.

File Security and Backup of Data

The customer is responsible for file security and backup routines for all simulation session data. All use and storage of simulation session data should be in accordance with local rules, regulations or laws and is the sole responsibility of the customer.

SimMan Essential Overview

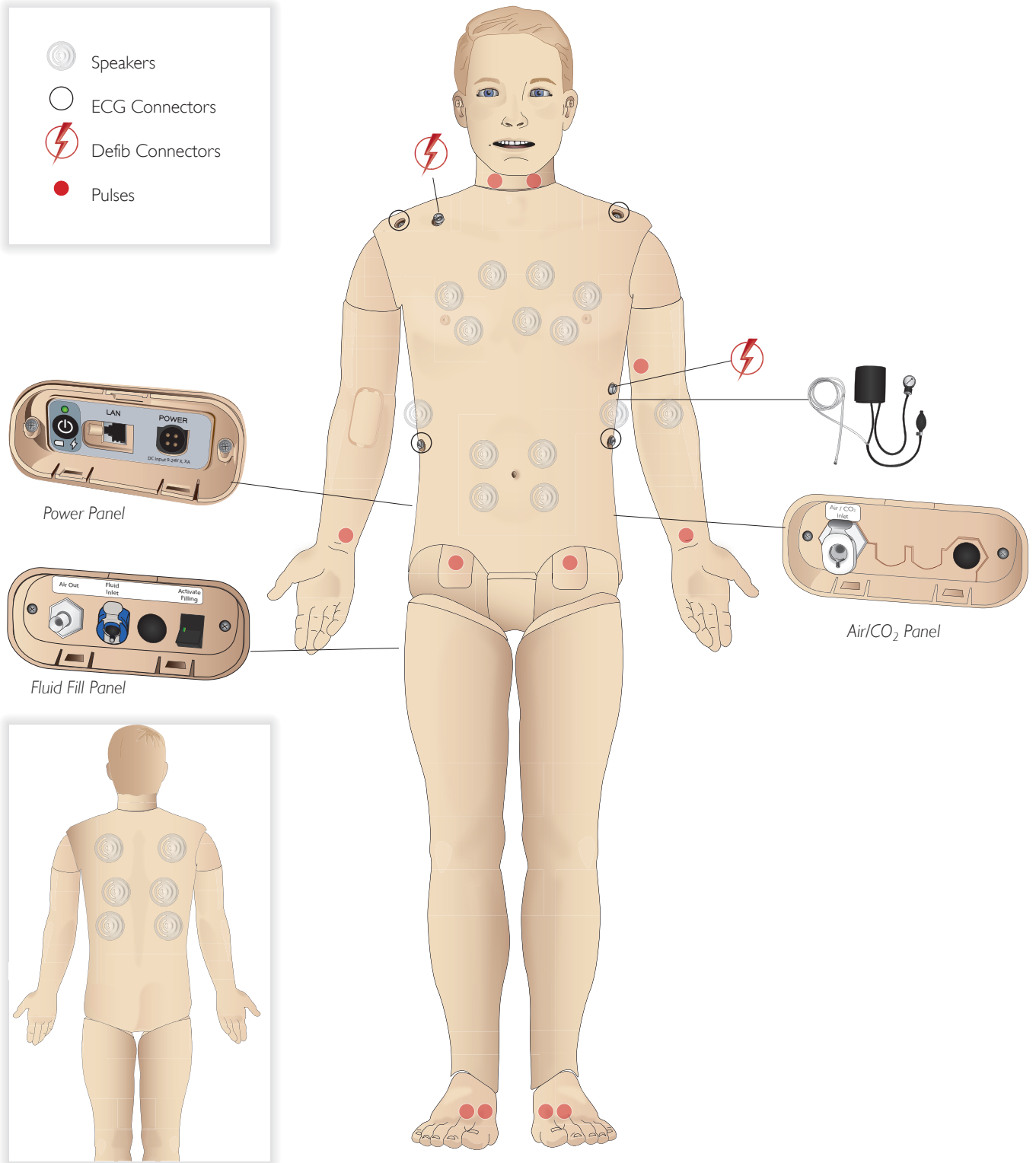

General

Main anatomical features

Dimensions (Patient Simulator only):
 1800mm (l) x 550mm (w) chest (5.90 ft x 1.80 ft)
 Weight (Patient Simulator only): 38.5kg (85 lbs)
 Weight (with clothes): 40 Kg (88 lbs)
 Default male body with interchangeable genitalia pads.

Configurable Anatomical Features

Genitalia

The Patient Simulator comes with a neutral genitalia pad as default. The pad can be changed for a male or female module, both included with the SimMan Essential System. See *Changing Genitalia Modules* section.

Teeth

Patient Simulator comes with a set of soft teeth as default. These can be exchanged for a hard set of teeth, included with the SimMan Essential System. See *Changing the Upper Dentures* section.

Mobility of Joints

Neck: Movement can be on a 3-axis movement of head. Range of movement can be restricted. See *Airway Features* section.

Shoulders: 3-axis rotation
 Lumbar: 1-axis
 Elbows: Fixed, no mobility
 Wrists: 3-axis rotation
 Thumbs: Free mobility
 Hip joints: 3-axis rotation
 Knees: 1-axis rotation
 Ankles: 1-axis rotation

 *Note: Do not remove protective bushings at shoulder or lower back. These are present to protect users from pinch points.*

Laerdal Simulation Software

To run a simulation, LLEAP (Laerdal Learning Application) must be started from Laerdal Simulation Home on the Instructor PC.

Laerdal Simulation Home

Laerdal Simulation Home is an application from where LLEAP and other Laerdal programs related to patient simulation can be found and started. The help files can also be opened from here. Laerdal Simulation Home is located in the Laerdal Medical folder under the Windows start menu (Windows 7).

Software used in a simulation session comprises the following main applications:

- LLEAP (Laerdal Learning Application)
- Voice Conference Application
- Patient Monitor
- SimView Server or Session Viewer

In addition SimDesigner and other applications are also used for designing or preparing a simulation.

LLEAP

LLEAP is the instructor's application from where the simulation session is run, controlled and monitored. LLEAP can be operated in Automatic or Manual mode. Automatic mode is used for preprogrammed scenarios while Manual mode allows the instructor full manual control of the simulation session. Running simulations in Manual Mode requires some medical expertise to create clinically sound simulations.

Voice Conference Application (VCA)

The VCA Software allows the instructor to communicate through the simulator during the session. VCA can also be used to communicate with other instructors on a network, and create separate channels where only members can communicate.

Patient Monitor

The Patient Monitor application emulates a typical hospital patient monitor. It is the learner's console and can be set up and controlled by the instructor, as well as by the learner through on-screen touch menus.

Session Viewer And Simview Server

Session Viewer and SimView Server are applications that record video and patient monitor screen captures during simulation, in addition to providing an interface to debrief your session. After a session is ended, log files generated in LLEAP are transferred and merged with the video files in Session Viewer or SimView Server for the debrief.

Session Viewer typically runs locally on the same computer as used for LLEAP, SimView Server runs on a dedicated server in the local network. During the first start-up of LLEAP, you are prompted to select a debriefing system available on your computer or on a local network. This can be changed later.

Other Applications

There are also other programs that are used in conjunction with the simulation sessions, for example License Manager for handling program licenses and Simulator Firmware & Network Fixer for updating the firmware of the simulators or troubleshooting network problems.

SimDesigner

The SimDesigner application allows you to configure your own preprogrammed scenarios. It can also be used to analyze and print out a graphical representation of a scenario.

SimDesigner must be installed to allow conversion of legacy instructor application files to LLEAP compatible file formats.

For a full overview of all applications and their help files, start LLEAP Home.

Web Downloads

Visit www.laerdal.com/download to download the latest User Guide and Software.

Airway Features

The airway is anatomically modeled as far as the bronchia.

The airways can be manipulated by a learner:

- Head tilt/Chin lift
- Jaw thrust w/articulated jaw
- Cricoid pressure and manipulation
- Suctioning (oral & nasopharyngeal)

If the tongue fallback feature is enabled, head tilt is required to open the airways for mask ventilations.

The Patient Simulator may be ventilated by normal and emergency methods:

- Bag-mask ventilation
- Orotracheal intubation
- Nasotracheal intubation
- Transtracheal intubation

Prior to using airway adjuncts, apply a small amount of Laerdal Airway Lubricant to the equipment. Do not spray lubricant directly into the airway.

The following equipment or methods are suitable to secure the Patient Simulator's airway:

- Laryngeal mask airways: The airways are designed for use with size #4, but size #5 may also seal correctly.
- Endotracheal tube intubation, Size ID 7.5 - 8.5 is suitable, but using the smaller size reduces wear of the Patient Simulator's airways.

Use of a malleable stylet is recommended - make sure it does not extend beyond the ET tube.

Recommended styles:

- i-Gel
- Fiberoptic intubation
- Combitube (size small adult is suitable)
- Retrograde intubation
- Needle cricothyrotomy
- Surgical cricothyrotomy

The following Patient Simulator features indicate incorrect tube placement:

- Right main stem intubation – unilateral chest rise
- Stomach distention
- Lack of chest sounds, CO₂ exhalation (see *Breathing Features* section)

Configurable Airway Features

Patient Simulator features may be configured to present various airway scenarios:

- There are two settings of airway resistance: On/Off
- Tongue edema - multiple levels
- Pharyngeal swelling
- Laryngospasm
- Decreased cervical range of motion
- Trismus
- Teeth - soft upper dentures may be replaced with a hard set of teeth for enhanced realism while practicing intubations.

During simulation, the following conditions can be set:

- Can't intubate/can ventilate
- Can't intubate/can't ventilate

The following information is automatically registered in the SimMan Essential simulation session:

- Detection of proper head position.
- Jaw Thrust
- Pneumothorax decompression
- Ventilations
- Stomach distension

 Note: In LLEAP the airway and breathing status for the current simulator is shown in a window. Settings for lung resistance can be made. See LLEAP Help for further information.

Breathing Features

The SimMan Essential can simulate spontaneous breathing:

- Bilateral and unilateral chest rise and fall
- There are 2 settings for airway resistance: on - off.
- Normal and abnormal breath sounds
- 5 anterior auscultation sites and 6 posterior auscultation sites
- Unilateral, bilateral and lobar breath sounds
- Oxygen saturation and phlethysmogram
- CO₂ exhalation for use with third-party End-Tidal CO₂ detectors (Requires connection to an external CO₂ reservoir)

 *Warning: Do not ventilate the Patient Simulator with oxygen enriched air or flammable gass.*

 *Caution: Do not ventilate Patient Simulator lungs using humidified air.*

Patient Monitor features - Breathing

- SpO₂
- Airway respiration rate (awRR)
- End-tidal CO₂ (etCO₂)
- End-tidal O₂ (etO₂)
- inO₂
- pH

Lung specifications

- Max tidal volume: 1.2 liters.
- Max tidal volume registered in LLEAP is 900ml. All volumes higher than 900ml will register as 900ml.
- Max airway pressure: 80 cm H₂O.
- Simulated stomach inflation starts from approximately 40cmH₂O airway pressure.

 *Note: Lungs are not intended for use with PEEP-valves.*

Pneumothorax

Tension pneumothorax with needle decompression can be performed at bilateral mid clavicle line, 2nd intercostal space. The pneumothorax bladders may be pierced +/-10 times, the pressure inside the bladder will drop after repeated puncturing.

A 22 (or smaller) gauge needle is recommended for decompression of the chest. Using a smaller gauge needle increases the longevity of the chest skin and bladders.

However, a too small gauge prevents automatic detection of the decompression event in the simulation model.

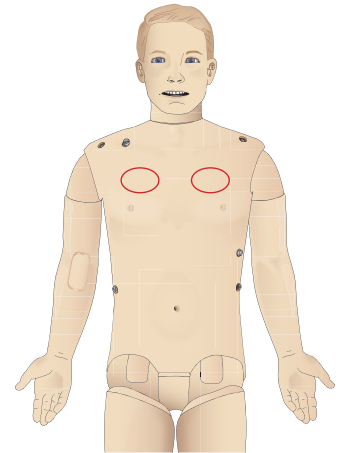

Chest Tube Insertion

Chest tube insertion can be simulated, Exploration and cut can be made at left or right mid-axillary line in the 4th and 5th intercostal space.

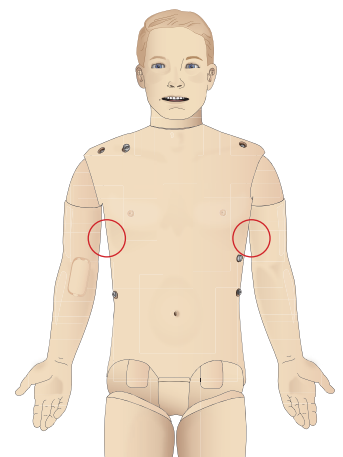

Circulation

Cardiac Features

- Extensive ECG library, pulses from 0-220.
- Heart sounds - for every anterior location
- ECG rhythm monitoring (4-connector, 3-lead ECG)
- 12-lead ECG display
- Pacing
- Defibrillation and cardio version using live defibrillators

Defibrillation

- With live defibrillators; energy level and waveform model is registered by the Patient Simulator.
- The energy levels and number of shocks required for automatic conversion are set in each simulation Patient Case.

Defibrillation Studs

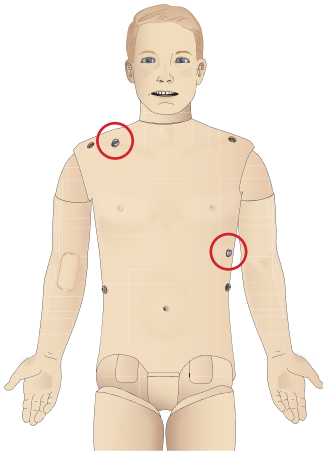

3-Lead ECG Studs

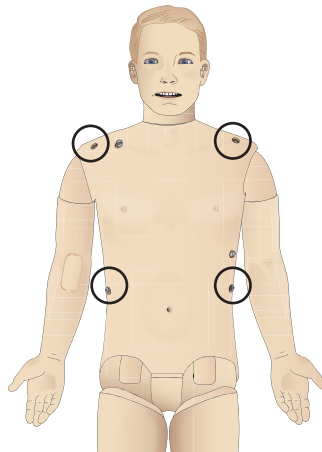

Circulation features

- BP measured manually by auscultation of Korotkoff sounds
- Carotid, brachial, radial, femoral, dorsalis pedis, and posterior tibialis pulses synchronized with ECG
- Pulse strength variable with BP
- Pulses are synchronized with ECG when the instructor sets the pulse strength manually
- Pulse palpation is detected and logged

CPR

- Compliant with 2015 Guidelines
- Compressions generate palpable pulses, blood pressure wave form, and ECG artifacts
- Realistic compression depth and resistance
- Detection of depth, release and frequency of compressions
- Real-time view of Quality of CPR on the Instructor's PC

 *Warning: Do not use automated chest compression machines on the Patient Simulator.*

Patient Monitor features - Circulation

- ECG (12-lead) and heart rate (HR)
- Pulse
- NBP
- ABP
- PAP
- C.O.

Patient Monitor features - Temperatures

- TPeri
- Tblood

 *Note: A variety of settings in the Circulation and Fluids window can be made in LLEAP. See LLEAP Help for further information.*

Sounds

Two types of sounds can be used in a scenario:

- Body sounds
- Vocal sounds

The sounds can be triggered by the scenario or controlled by the instructor.

Body Sounds

The body sounds are simulated sounds from a human body, like heart, lungs, and bowel sounds. The sounds are integrated and generated in the Patient Simulator and transferred through the integrated speakers.

Vocal Sounds

The vocal sounds are sounds from the throat like coughing, moaning, and crying as well as spoken words. The sounds are integrated in LLEAP and transferred to the Patient Simulator through the VCA.

In addition, the instructor can communicate through a microphone and the voice is then transferred to the Patient Simulator through the VCA.

 *Note: A variety of settings in the Sounds window can be made in LLEAP. See LLEAP Help for further information.*

Eyes Settings and Configuration

The calculated Glasgow Coma Scale score for the Patient Case is displayed in LLEAP. The following sources of information help the learner to judge the state of disability:

Eyes

- Blinking eyelids
- Eyelids: open, closed or partially open
- Eyelids can be opened for examination by the learner
- Set of interchangeable pupils available

 *Note: A variety of settings in the Circulation and Fluids window can be made in LLEAP. See LLEAP Help for further information.*

Drugs and IV

Drugs and drug concentrations can be registered manually by the instructor in LLEAP.

Patient Monitor features – Drugs

- Train-of-Four (TOF)
- in N₂O, et N₂O
- Anesthesia agents
- Lab reports

User-replaceable items, spare parts

- Intra-muscular Pad
- Tibial IO Pad

Vascular Access (IV and IO) Locations

Intraosseous access with needle insertion is possible through the left tibia. The IO pads may be punctured numerous times before being replaced.

To replace the IO modules, see the *Simulation Setup* section.

 *Caution: Do not inject fluids into these pads unless approved IO modules with fluid outlets are in place.*

Intra-muscular (IM) Injection

Use the pad placed under the Torso Skin on the right buttock for intramuscular injection training.

SimMan Essential Clothing

Included with the Patient Simulator:

- Shirt, with side zippers
- Trousers, with full-length side zippers
- Boxer shorts underwear
- Belt

 *Note: For washing instructions see care labels.*

Simulated Removal of the Clothes

To simulate cutting with scissors: unzip the zippers placed alongside the seams on both sides.

Inserting and Connecting the Batteries

Open the torso as described in steps 1 - 4, *Opening the Torso*. To remove the batteries, follow the same procedure in reverse.

- 1 Release the battery clamp by unhooking the clips on either side.

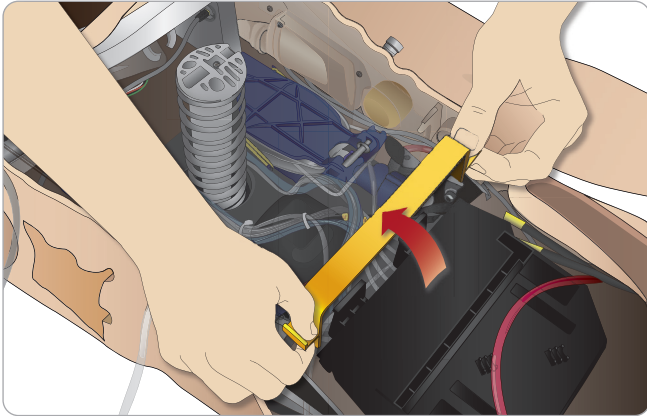

- 2 Insert both batteries into the battery tray.

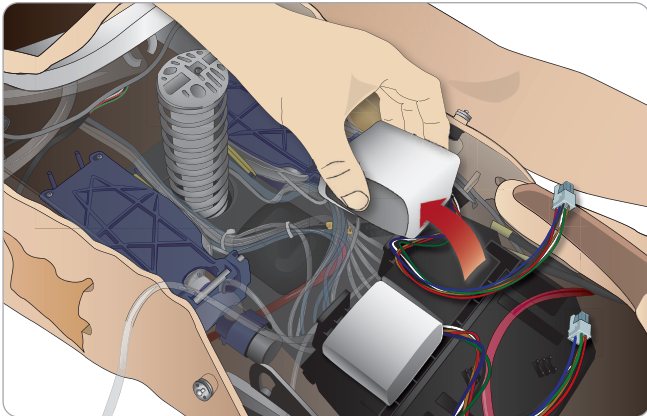

- 3 Snap the battery clamp back into place over the batteries.

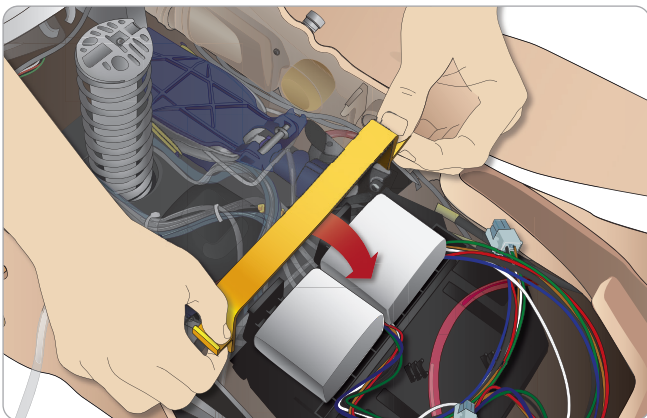

- 4 Connect the corresponding battery cables from the batteries to the torso.

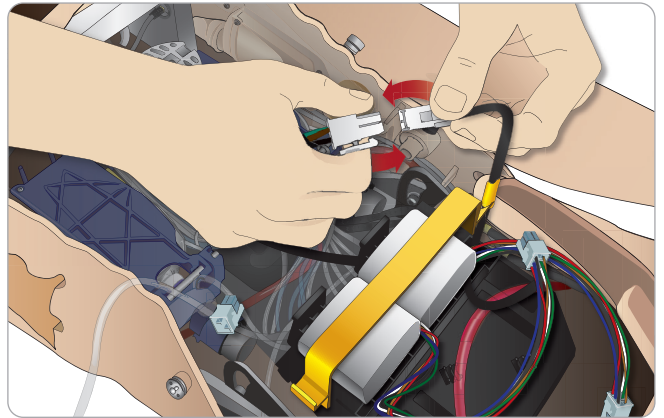

After connecting the batteries, connect the Patient Simulator to the external power supply (12V to 24V) while turned OFF.

The batteries will charge if the Patient Simulator is ON and connected to an external power supply in the range of (20V - 24V)

Battery - Cable and Tube Descriptions

Name/Label	Tube/Cable Color	Connector Description
Battery 1	Black harness cable	Black rectangular connector, 6 lead
Battery 2	Black harness cable	Black rectangular connector, 6 lead

The Power Panel

The power panel is found on the right side of the Patient Simulator, under a loose skin flap. Lift the skin flap and pull out the protective cover.

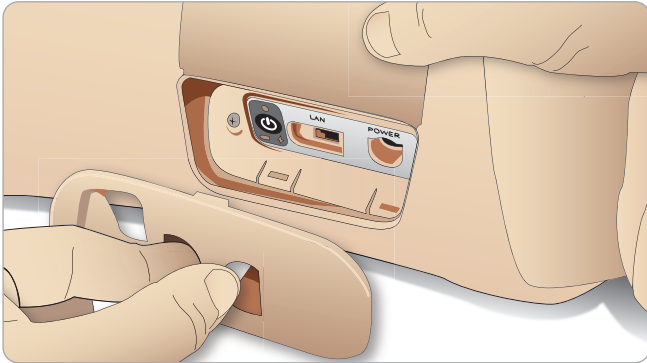

To ensure easy access, use the zippered clothing provided with the SimMan Essential Patient Simulator.

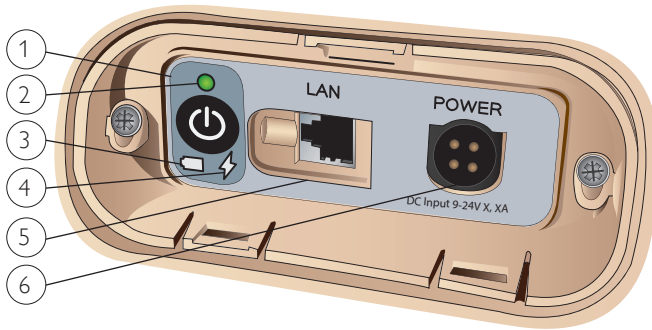

Power panel overview

- 1 Power ON/OFF button
- 2 Power status indicator
- 3 Battery status indicator
- 4 Charging status indicator
- 5 LAN network cable connector
- 6 External power supply connector

Power Status Indicator Description

Indicator Light Color	Power Status	Battery Status	Charge Status
Red	Power save*	0% - 20%	Not charging**
Yellow	Start up	20% - 70%	Charging
Green	Running	70% - 100%	Charge almost complete***
No light	Off	Off	No charge****

* Blinking light
 ** One or both batteries missing, overheated, damaged or otherwise not able to charge
 *** Not recommended to charge the batteries too long
 **** No power input, batteries are charged.
 Power Save is activated whenever Patient Simulator is paused.

Charging the Batteries

Inside the Patient Simulator

- 1 Connect the Patient Simulator to the external power supply with a power cord and plug that meets local specifications.

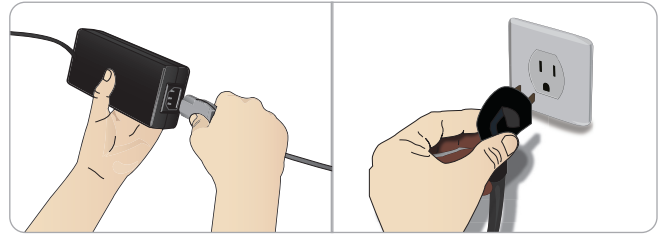

- 2 Plug the power supply into a wall outlet and connect the power cable to the power inlet on the Patient Simulator's power panel.

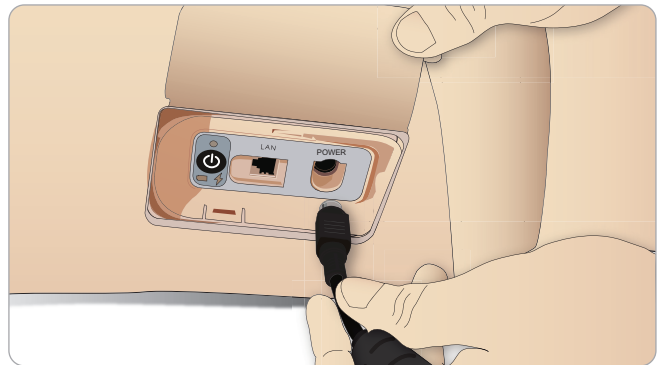

- 3 Press the ON button to power on the Patient Simulator.

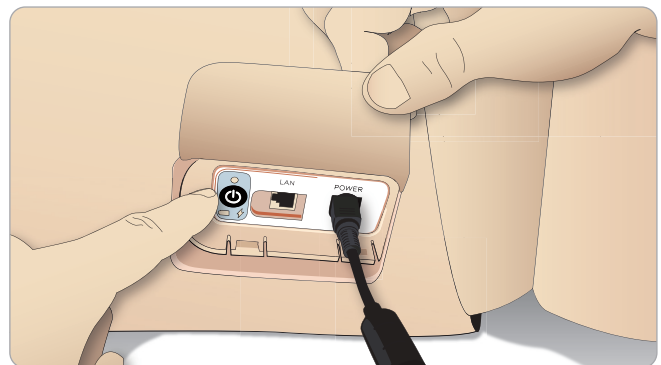

Note: During start up, the Patient Simulator's eyes will blink and the power status indicator light will be yellow.

Caution: After Patient Simulator is turned off, wait 20 seconds before restarting. If not, Patient Simulator may not function properly.

External battery charging

The battery charger comes with 5 international plugs. Connect the appropriate plug to the charger:



- 1 Connect the charger to a power outlet and connect the Patient Simulator battery to the charger.

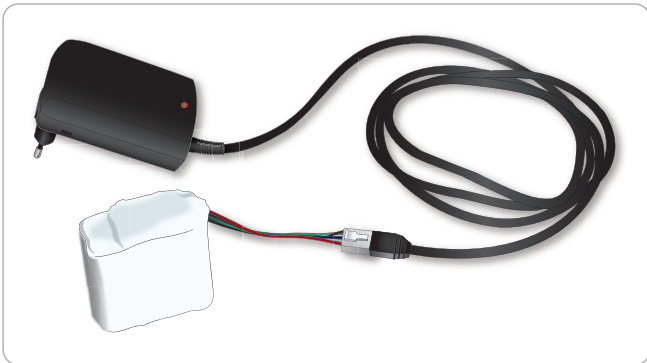

- 2 The indicator light on the battery charger shows charge status.
- 3 Battery charging time is approximately 6,5 hours.

The external battery charger should only be used with SimMan Essential batteries.

Charger Indication

Light Code	Light Color	Characteristic
Standby	Yellow	Steady
Pre-charge	Yellow	Normal Blink
Rapid charge	Green	Rapid
Maintain	Green	Normal Blink
Ready	Green	Steady
Wait	Alternating	Alternating
Error	Yellow	Rapid

Battery Use

- Always use two SimMan Essential batteries to power the Patient Simulator.
- Ensure that the batteries are properly connected.
- Charge the batteries regularly.
- Check LEDs on Patient Simulator's power panel for battery status.
- Charge both batteries before the battery charge drops below 15% or the battery light indicator is red. This can be monitored in the technical status window on the Instructor PC.
- The Patient Simulator will automatically shut down if: battery temperature rises above 60°C (140°F) or the remaining charge falls below 6% on one of the two batteries.

View Battery Status in LLEAP

Check the power indicator in the Simulator Status window in LLEAP according to the instructions in LLEAP Help.

Changing Batteries during a Simulation Session:

- 1 Press <Pause Session> on Instructor PC. Access the batteries as described in *Inserting and Connecting the Batteries*.
- 2 Replace one battery at a time to avoid loss of simulation data.

Storage and Transportation

- Never store fully charged batteries for longer than a month.
- Never store the batteries inside the Patient Simulator.
- Store batteries in a refrigerator i.e. temperature 0°C - 4°C (32°F - 40°F).
- The two simulator batteries can be transported in the Patient Simulator during air freight.
- When transporting spare batteries please contact the airline or freight company for the latest transport regulations.

Battery Maintenance

- On approximately every 30th charge cycle, drain the battery completely before recharging. To drain the batteries run the Patient Simulator on both batteries until automatic shut down.
- Expected battery life: 200 charge cycles.
- Replace only with Laerdal SimMan Essential batteries.

Battery Warnings

 *Warning: Do not run the Patient Simulator for more than 1 minute on a single battery.*

 *Warning: If both batteries are removed while the simulation is paused, the Patient Simulator will shut down and simulation data will be lost.*

 *Warning: Dispose of batteries in accordance with local regulations.*

 *Warning: The external battery charger is for indoor use only.*

 *Warning: The batteries should only be charged in temperatures ranging from 0 °C - 40°C (32 °F - 104 °F)*

 *Warning: Inserting and connecting batteries incorrectly, short circuiting or exposure to fluids pose an explosion hazard.*

 *Warning: Do not mistreat, disassemble or attempt to repair the battery.*

 *Warning: Do not use the batteries if they are visibly damaged, malfunctioning or appear to be leaking.*

 *Warning: Take extreme care to avoid direct contact with electrolyte, hot or smoking parts. In case of the above, disconnect and remove the battery when it is judged safe to do so.*

Using the Internal Compressor

The SimMan Essential Patient Simulator's chest movements, airway modes and fluid systems are driven by compressed air. The right leg contains a compressor and tank with reservoir for clear fluids.

For extended periods or stationary use, it is recommended to connect to an external source of compressed air. This reduces wear on the internal compressor and extends battery life of the Patient Simulator.

For instructions on connecting an external compressor and adjusting compressor default settings see *Air/CO₂ Panel* section.

To avoid overheating and reduce wear

- If using the Patient Simulator in high temperatures, always allow the simulator to cool down between training sessions.

Turning the Internal Compressor OFF Using LLEAP

To switch OFF the internal compressor (to conserve the simulator batteries and reduce wear), do the following:

- 1 In LLEAP, select the <Tools> menu.
- 2 From <Simulator Setup>, click <Turn off internal compressor>.

Changing Default Compressor Settings Using LLEAP

Change default compressor settings via the Profile Editor:

- 1 Open the Profile Editor from the <Tools> menu in LLEAP.
- 2 Select the <Manikin hardware> tab in the Profile Editor.
- 3 From the compressor setup option, choose <Internal default>, <External default> or <Remember last setting>.

Air/CO₂ Panel

The Air/CO₂ panel is located on the left side of the torso. To access the panel, lift up the simulator skin flap and remove the protective covering. Connect external Air/CO₂.

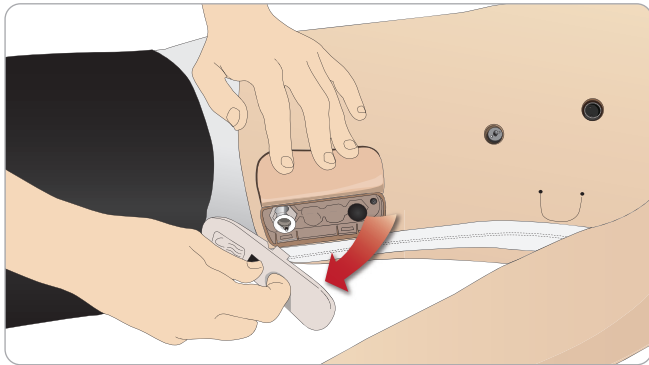

Air/CO₂ Panel has 2 Connection Ports

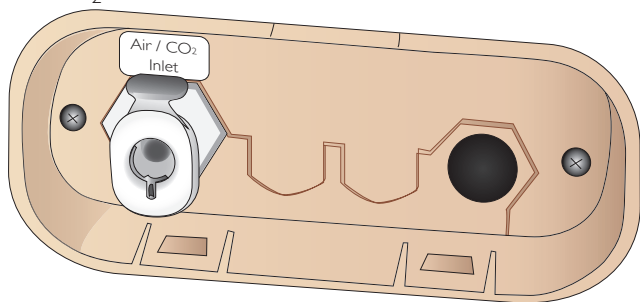

Connecting External Air and CO₂ Supply

An internal compressor is located in the right leg of the Patient Simulator. It is recommended to use an external source of compressed air whenever the Patient Simulator is stationary over extended periods of use.

Connect CO₂ only if the Patient Simulator is required to exhale CO₂ with each ventilation. Exhaled CO₂ can be detected with a real capnographic device. The Patient Simulator will only exhale CO₂ when a capnograph is registered as being connected to the system.

- 1 Connect a suitable CO₂ source to a Laerdal external compressor or regulator panel.
- 2 Connect a Laerdal double-lumen Air/CO₂ tube from the external compressor or regulator panel to the Air/CO₂ inlet on the panel.

Note: For more information on external compressors and regulator panels compatible with SimMan Essential, contact your local Laerdal representative.

The IV Arm

Follow these instructions when using the IV Arm for SimMan Essential.

The Patient Simulator must be switched ON when performing the following.

IV Arm with Skin

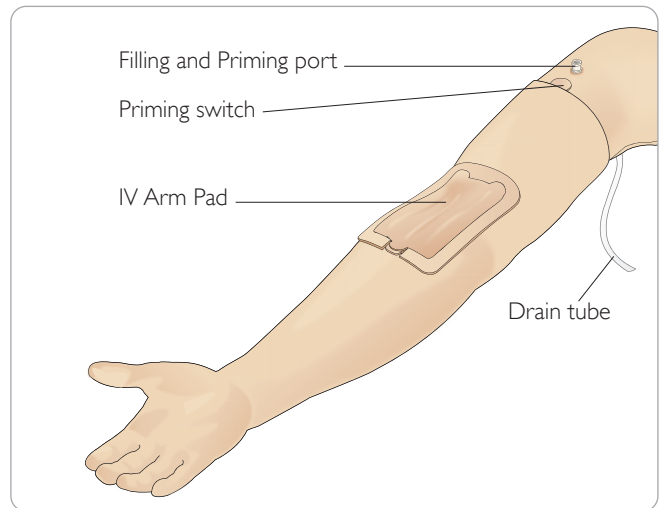

IV Arm without Skin

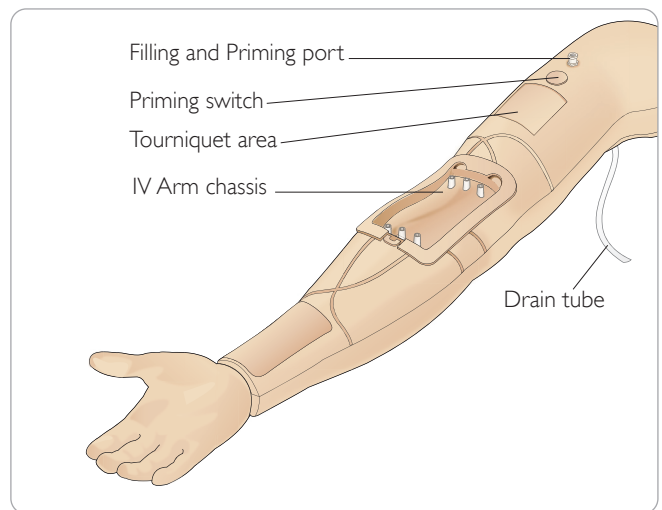

The IV Arm Pad

The new IV Arm Pad is intended to take up to 10 catheter insertions in each of the 3 veins, using a size 20 G catheter. Distribute the insertions of the IV catheter evenly and only in the 3 highlighted areas.

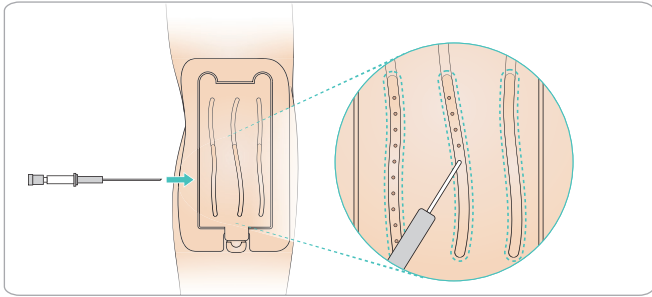

If the IV Pad leaks from any of the insertion points, massage the leak area. Replace the IV Pad if leaking continues.

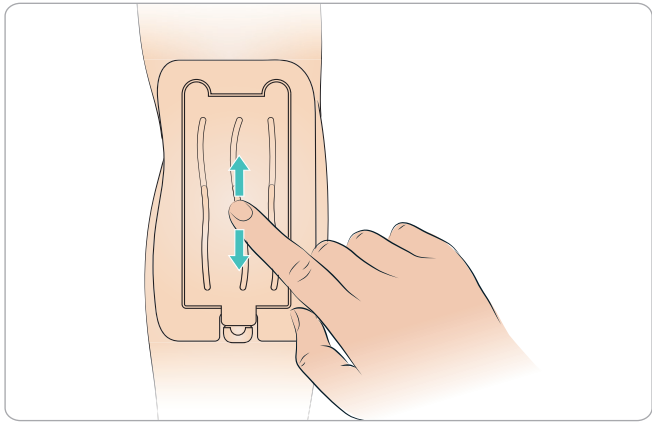

Filling and Priming the IV System

- 1 Ensure that the IV Arm is connected to the Patient Simulator and the Patient Simulator power is ON.
- 2 Ensure that the IV Arm Pad is fitted correctly.

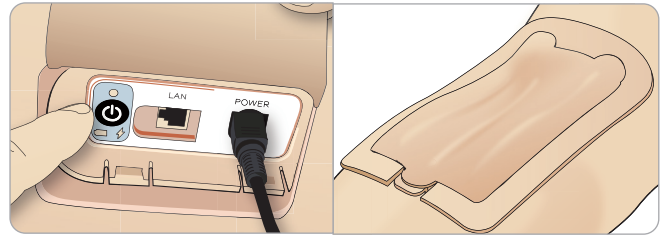

- 3 Attach a collector bag to the drain tube of the IV Arm. The bag should be placed on the bed beside the Patient Simulator or at the same level, to allow fluid to drain into it.
- 4 Connect a blood filled syringe (min 40ml) with luer lock to the Filling and Priming port.

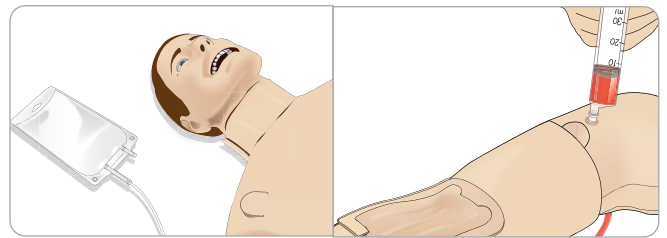

- 5 Press the priming switch to open the system.
- 6 Slowly fill the system with simulated blood. Continue this operation until there are no air bubbles coming out through the drain tube. Release the priming switch.
- 7 Continue to slowly fill with no more than 16ml of simulated blood, or until you feel resistance in the syringe.
- 8 Remove the Syringe. The IV Arm is now ready for use.

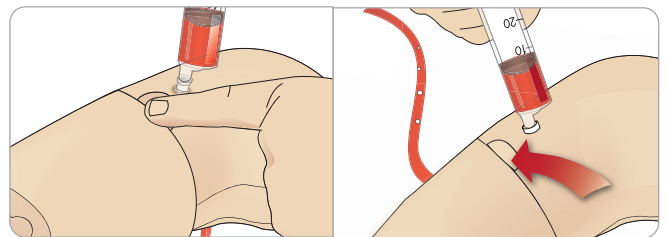

Note It is important that the Arm is filled slowly to prevent damage to the IV Arm Pad causing leaks.

Note: The IV Arm Pad is designed for use with a 20 GA Intravenous Catheter.

Removing and Replacing the IV Arm Pad

- 1 Ensure that the Tourniquet Area is not activated i.e. remove the tourniquet.
- 2 Remove the IV Arm Pad by pulling at the tabs on edge of the IV pad.

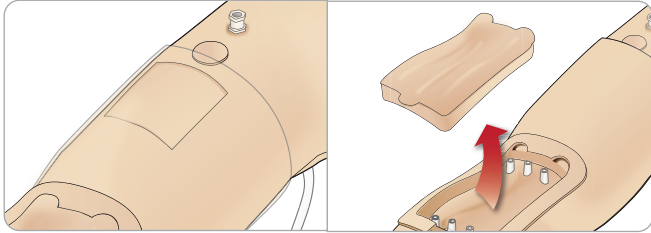

- 3 Remove excess blood that may accumulate in the IV Arm chassis.
- 4 When replacing the IV Arm Pad, ensure that it is pressed firmly into all connection points to provide a watertight seal.

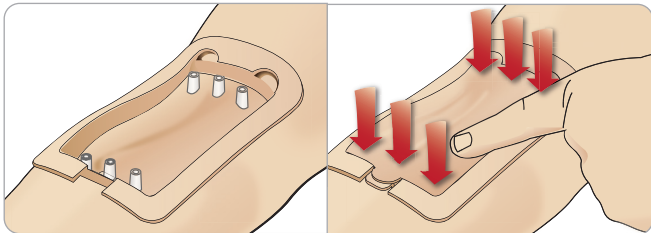

- 5 Fill and Prime the system as instructed in the previous section.

Refilling the IV Arm with Blood

- 1 If the veins do not respond (energize) when the tourniquet is applied it is likely that the system requires refilling with blood.
- 2 Connect a blood filled syringe and slowly fill with no more than 16ml of blood or until you feel resistance. Remove the Syringe.

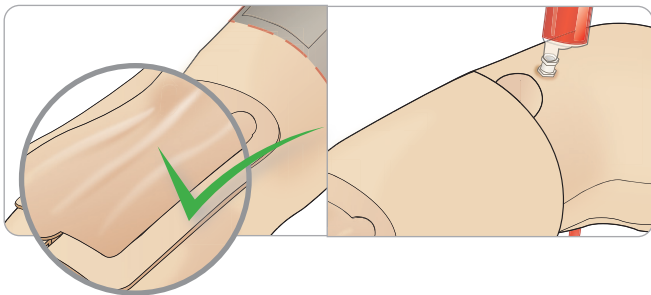

The IV Arm is now ready for use.

Cleaning the System

After each session and before storage, clean the IV Arm system:

- 1 Make sure the collector bag is connected to the drain tube.
- 2 Connect a syringe filled with Isopropanol 60%-70% to the IV Catheter. Press the prime switch, and flush the IV Arm system with Isopropanol. Release the prime switch when done.

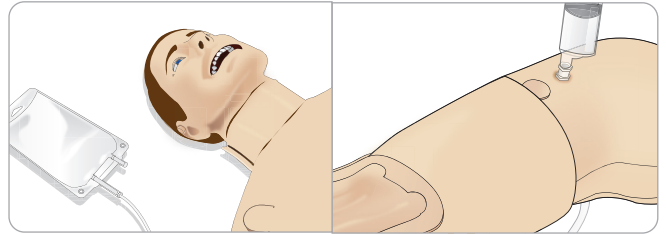

- 3 Connect a syringe filled with air to the IV Catheter. Press the prime switch, and flush the IV Arm system until only air exits the drain tube. Release the prime switch when done.

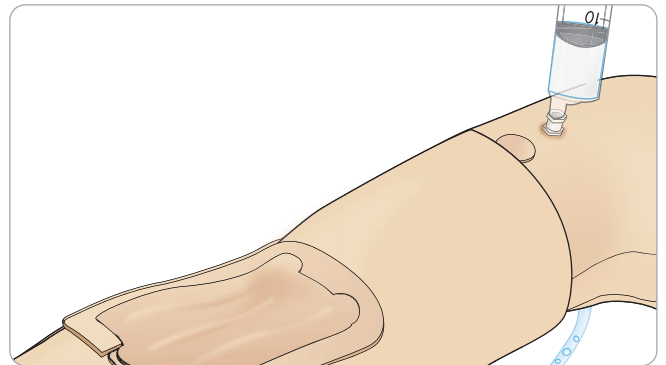

Essential Right Leg Fill Panel

The Right Leg fill panel is located at the top of the right leg near the pelvis. The fill panel contains connectors for filling the fluid reservoirs.

Note: Make sure the Patient Simulator power is on.

Fill Simulator Fluid Reservoir

- 1 Roll the right leg skin down to expose the fill panel.
- 2 Connect fluid fill unit tubes to the fluid and air connectors in the Right Leg panel.
- 3 Push the fill button on the panel. The button will light up and fluid will flow into the manikin.
- 4 When the flow stops, disconnect the fill unit.
- 5 Push the fill button on the panel. The light will go out.

Note: Disconnect tubes from the manikin before pushing the fill button. Pushing the button before disconnecting the tubes will initiate draining of the tank.

Empty Internal Fluid Reservoir

- 1 Connect an **empty** fluid fill unit to fluid connector in the Right Leg panel.
- 2 Fluid from the internal reservoir will drain into the bottle.
- 3 When the flow stops, disconnect the fluid connector:

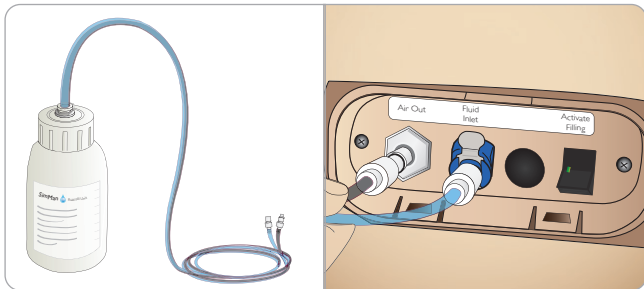

Run Simulator with External Fluid

- 1 **Drain the internal reservoir.** Follow instructions for *Empty Internal Fluid Reservoir*.
- 2 After draining the internal reservoir, fill the fluid fill unit and connect to the simulator.
- 3 Push the fill button on the panel. The button will light and fluid will flow into the simulator.
- 4 Charge the system for 60 seconds before starting simulation.

Warning: Connecting a full fluid fill unit to a manikin with a full internal reservoir will result in system overflow. Fluid will drain out of the right leg. Repeatedly overflowing the system may damage the product.

Connecting Defibrillation Pads or Adapter Plates

The Patient Simulator can be defibrillated with semi automatic defibrillators and manual mode defibrillators.

Using Defibrillation Training Cables

The Patient Simulator is fitted with two defibrillator connectors (Apex and Sternum) for attachment of a Defibrillator Training Cable. Laerdal can provide adapters that make the Defibrillation Cable fit several defibrillator brands. Designated Training defibrillator pads may also be fitted around the defibrillator connectors to resemble real defibrillator electrodes.

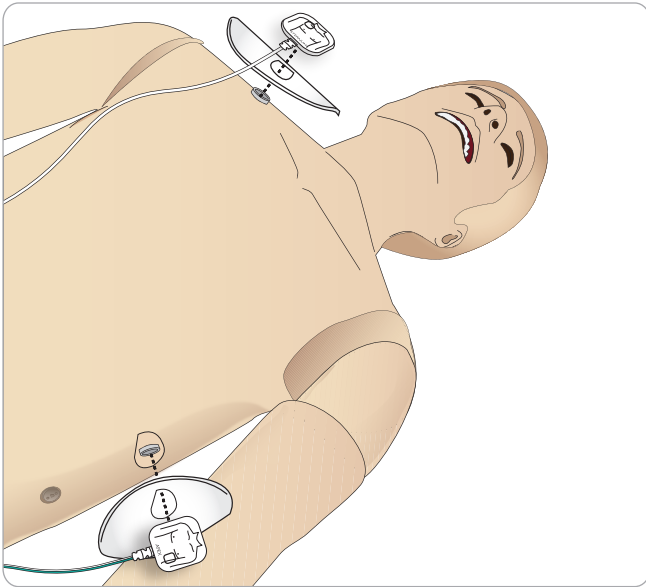

The Patient Simulator is not designed for use with single use real adhesive defibrillation electrodes.

Using Defibrillation Adapter Plates

To use a defibrillator with defibrillator paddles on the Patient Simulator, the defibrillator connectors must be fitted with designated Training Defibrillator Adapter Plates.

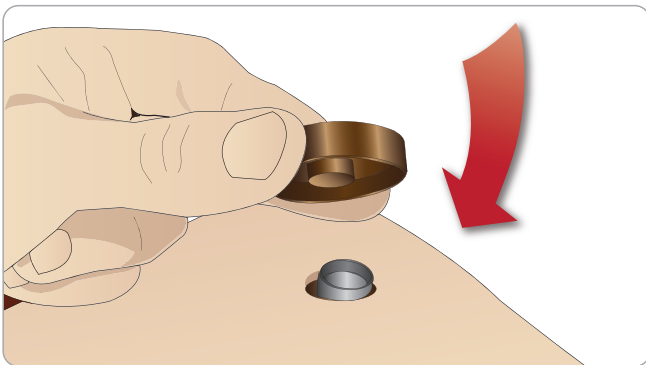

Press the Adapter Plates firmly into place.

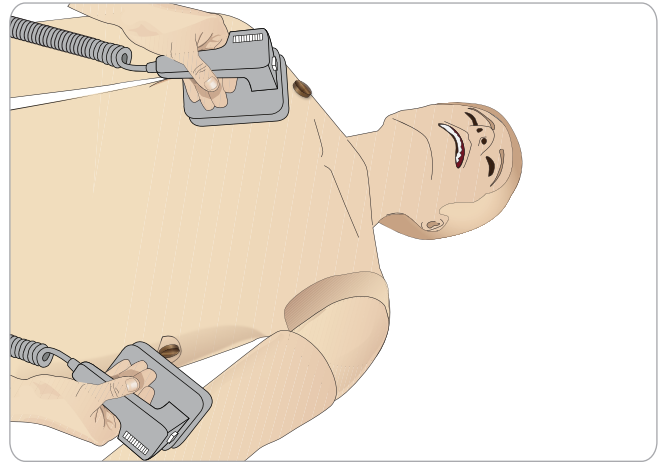

Note: Always follow the safety instructions from the defibrillator manufacturer when using the defibrillator on the Patient Simulator.

During Defibrillation

During live defibrillation, the defibrillator and Patient Simulator may present a shock hazard. All standard safety precautions must be taken when using the defibrillator on the Patient Simulator.







Note: Defibrillation must be performed on the defibrillator connectors only.

To prevent overheating during defibrillation, do not exceed a defibrillation sequence of 3 shocks in 45 seconds followed by 1 minute of CPR.

After 30 minutes there must be at least 15 minutes pause in defibrillation before starting a new sequence.

Note: Do not repeat this for more than a 4 hour period.

Warnings and Cautions

-  **Warning:** Do not spill fluids on the defibrillator connectors. Wet defibrillator connectors may lead to a shock hazard during defibrillation of the simulator.
-  **Warning:** The Patient Simulator must not be in contact with electrically conductive surfaces or objects during defibrillation.
-  **Warning:** Do not defibrillate the Patient Simulator when it is OFF or if it is not functioning normally.
-  **Warning:** Do not defibrillate the Patient Simulator without the torso skin.
-  **Warning:** Do not defibrillate the Patient Simulator in a flammable or oxygen enriched atmosphere.
-  **Warning:** The Patient Simulator torso must always be kept dry. Allow the Patient Simulator to acclimate before defibrillating. Sudden changes in temperature (moving the Patient Simulator from a cold environment to a warm environment and vice versa) may result in condensation collecting on the base board and pose a shock hazard.

SimMan Essential will automatically shut down whenever it detects a significant increase in internal temperature. If automatic shutdown occurs, allow the Patient Simulator to cool down before resuming the training session. Open the torso skin to speed up the cooling process.

Warning: Ensure that the Patient Simulator defibrillators connectors are securely tightened before connection of the Defibrillation Training Cable or Manual Defibrillation Adapters. Loose connectors may represent a shock hazard.

Caution: Do not defibrillate on the ECG connectors on the Patient Simulator. This will damage the Patient Simulator.

Caution: In hot conditions, intensive defibrillation may cause thermal shutdown of the Patient Simulator.

Caution: To prevent torso skin electrode pitting, do not apply conductive gel or conductive defibrillation pads intended for patient use.

Caution: Do not use automated chest compression machines on the Patient Simulator.

Connecting the Blood Pressure Cuff

The Patient Simulator is delivered with a specially adjusted blood pressure cuff. Connect the tube to the white BP connector at the side of the Patient Simulator before use.

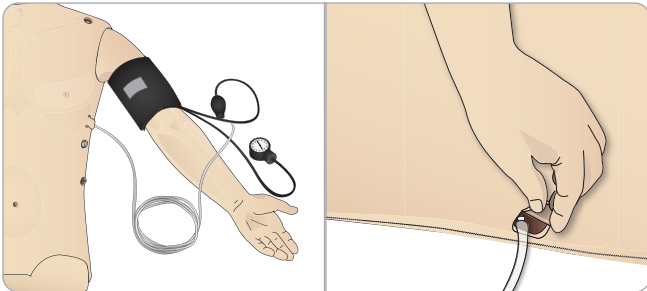

Calibrating the Blood Pressure Cuff Using LLEAP

- 1 Select <Tools> <Maintenance> and choose <Calibrate BP...>

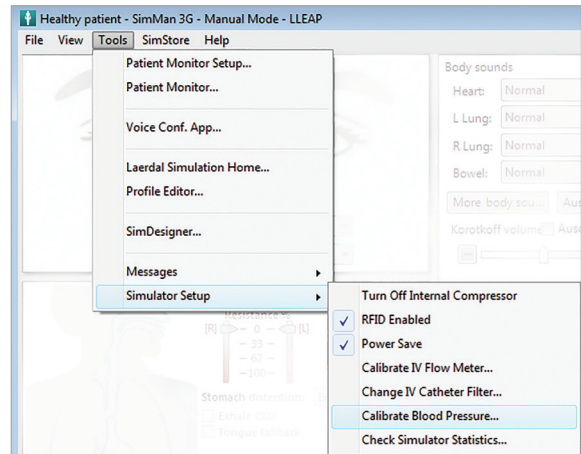

- 2 Follow the onscreen wizard instructions to perform the calibration.

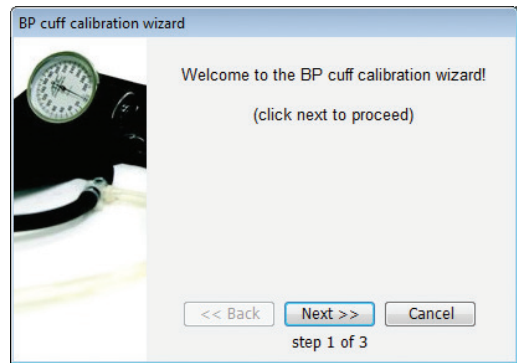

Connecting the SpO₂ Probe

The SimMan Essential SpO₂ probe is made up of a light diode and light sensor. When the beam between the diode and sensor is broken, the Patient Monitor Application registers that the SpO₂ probe is connected.

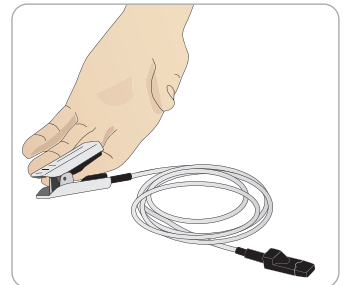

- 1 Connect the probe's USB plug to the Patient Monitor PC.
- 2 The probe can be placed on any suitable area on the Patient Simulator. Ensure that the probe is always firmly fixed in position.

Changing Genitalia Modules

The SimMan Essential is shipped with a neutral genitalia module as its default. The module can be exchanged for a male or female genitalia module with urine catheter to simulate urine flow and catheterization.

Note: The Patient Simulator legs do not need to be removed before the genitalia module can be replaced.

- 1 Remove the Patient Simulator's genitalia module by gripping the pad at the top and pulling forward and down.

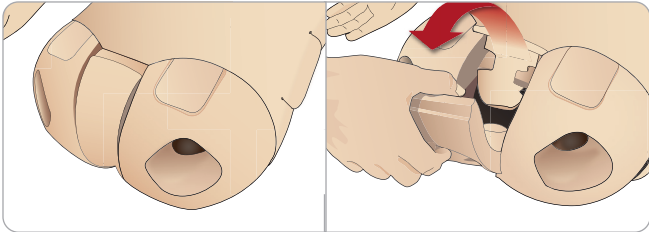

- 2 Disconnect any tubes or cables.
- 3 Connect the new genitalia module's urine tube and the catheterization sensor cable from inside the Patient Simulator pelvis to the urine bladder module.

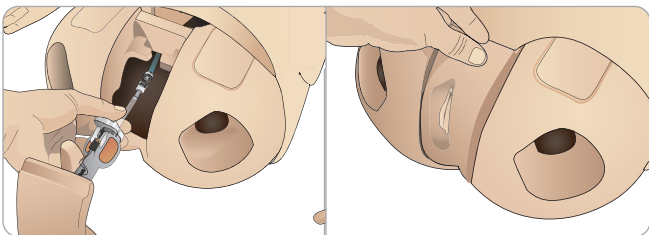

- 4 Place the new genitalia module back into the Patient Simulator's pelvis.

Changing the Upper Dentures

The SimMan Essential Patient Simulator comes with a set of soft upper teeth as default. The soft set may be replaced with a hard set of teeth.

- 1 Remove the teeth from the mouth.
- 2 Align the new set of teeth with the gums and push them back until the teeth engage and lock onto the gums.
- 3 Ensure that the new set of teeth is properly aligned with the gums before pushing them into places.

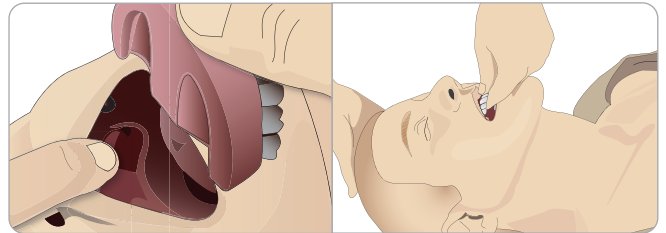

Changing the Irises

The irises can be changed to simulate different clinical states. The irises are secured by magnets in the eye socket. To change the irises use the especially adapted suction wand.

Before changing the irises during a simulation, stop the blinking function in LLEAP.

- 1 Moisten the suction cup before performing this procedure.

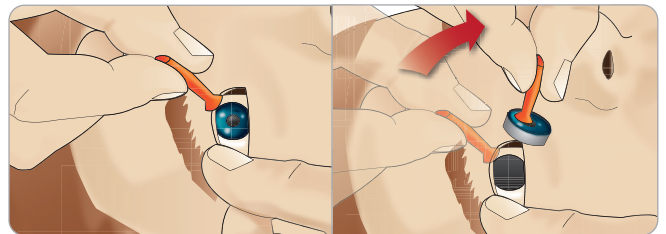

- 2 Pull and roll the iris up and down towards the Patient Simulator's mouth using a rolling motion.
- 3 Place the iris in the eye kit and select another from the kit.

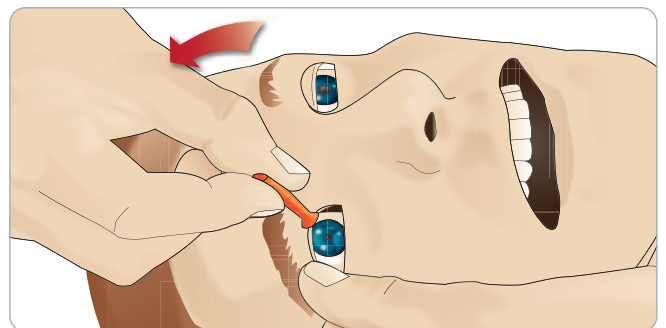

- 4 Insert the lower part of the iris into the socket until it connects with the magnet below. Repeat this for the other eye.

Replacing and Filling Tibial IO Unit with Blood

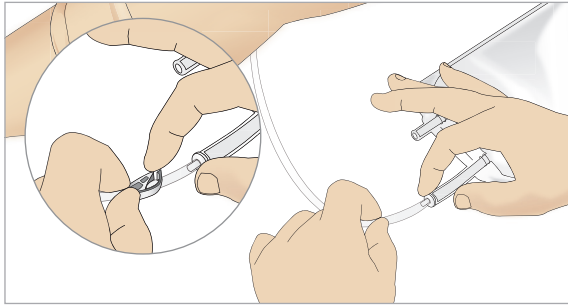

1 Attach the Tibial IO bag to the Tibial tube and close off the pinch clamp.

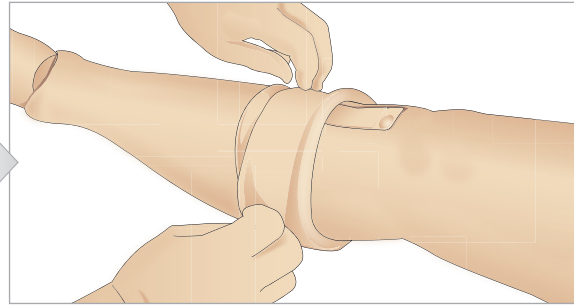

2 Roll the leg band, to expose the Tibial IO unit.

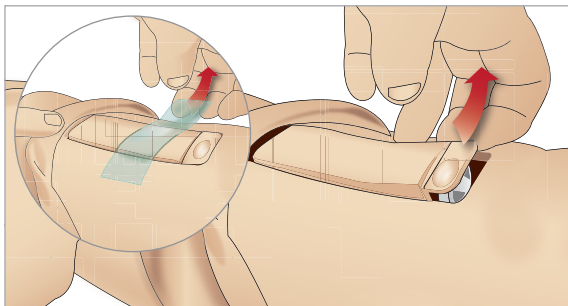

3 Remove the IO tape. Then remove the Tibial IO unit from the leg.

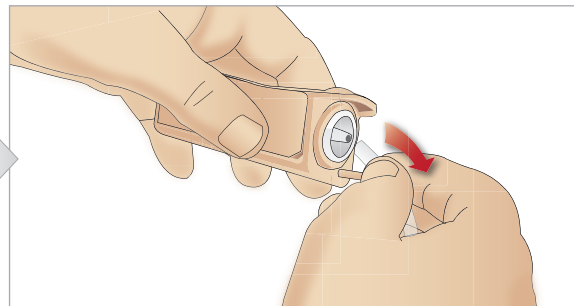

4 Remove the tube from the Tibial IO unit.

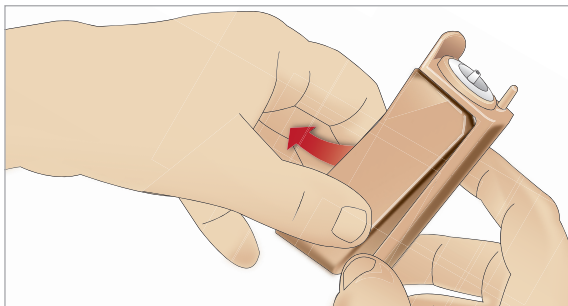

5 Remove the Tibial IO Pad from the Tibial IO chassis.

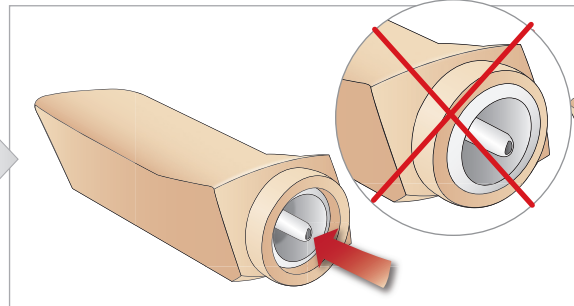

6 Before replacing the new Tibial IO, ensure that the nipple is retracted in the Tibial IO Pad.

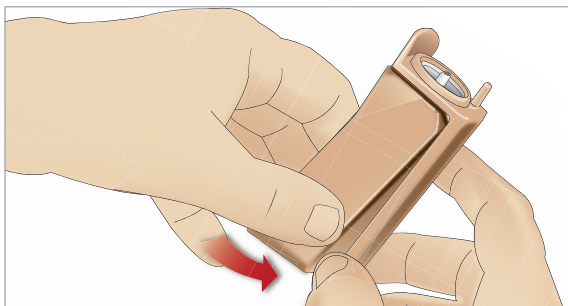

7 Fit the new Tibial IO pad into the chassis.

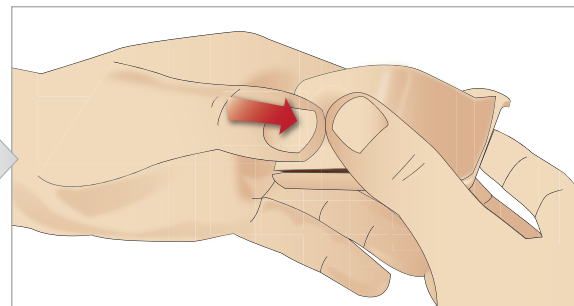

8 Secure the Tibial IO pad in place by pressing the rear of the pad with thumbs until the nipple moves forward and locks the unit in place.

SETUP

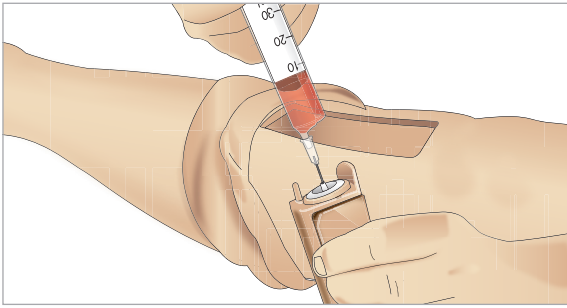

9 Fill the Tibial IO unit with 30 - 35ml of blood, ensure the Tibial Pad is completely full.

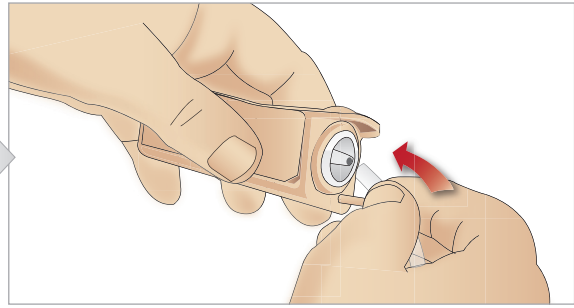

10 Connect the Tibial tube to the Tibial IO unit.

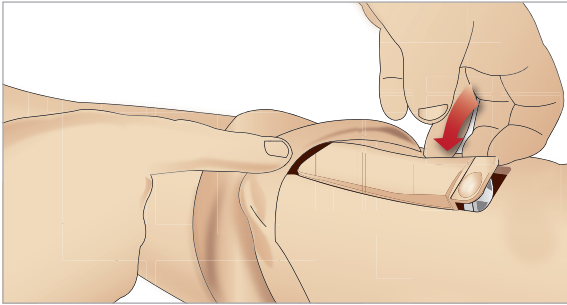

11 Replace the Tibial IO Pad and chassis, into the leg cavity.

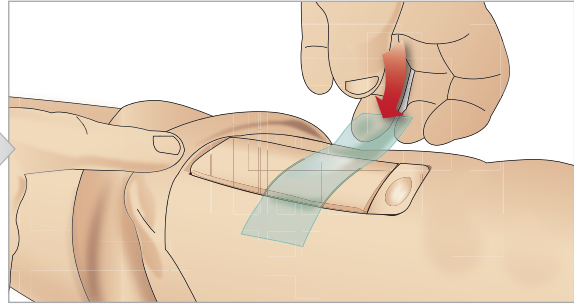

12 Affix the tape to keep the module in place.

Roll the leg skin up over the Tibial module. The Tibial IO is now ready for simulation.

The following devices have been tested and are approved for use with the simulator:

- BIG Automatic Intraosseous Device
- EZ-IO-G3, 15G x 1", 1.8mm x 25mm
- Jamshidi® Illinois Bone Marrow Aspiration/Intraosseous Infusion Needle. 18 Ga. 9/16" (14mm)-1 1/2" (38mm).



Note: in some cases, there will be no blood backflow when using the BIG Automatic Intraosseous Device

Transporting SimMan Essential

The SimMan Essential Simulation System consists of two cases for easy transport and storage; one for the Patient Simulator legs and one for the torso.



Each case has an extendable handle and may be stacked onto the integrated wheel frame for increased mobility.

Note: The SimMan Essential System exceeds the weight allowance on most commercial airlines. Some parts may have to be transported separately. For more information on weight restrictions contact the relevant airline.

Disassemble the legs from the torso and pack them into their respective cases before transportation or storage.

For instructions on how to disassemble the legs, see *Attaching the Left Leg* and *Attaching the Right Leg*.

Warning: The suitcases are heavy. Always ensure that they are firmly secured during transportation and storage so as not to cause personal injury or damage to the product.

Please be aware that both cases appear identical. Each case contains compartments for all accessories.

Torso Case with foam inserts

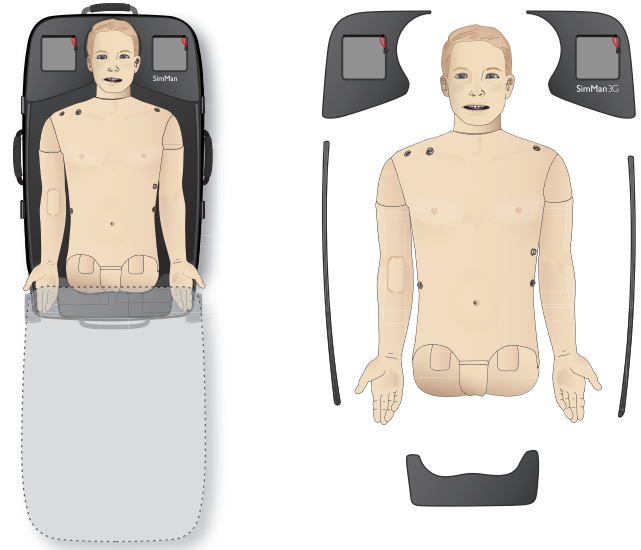

Leg Case with foam inserts



For more information on SimMan Essential accessories, see *Spare Parts and Accessories* section.

Note: Do not store or ship the simulator with Isopropanol or liquid in any of the fluid or liquid systems.

Unpacking the Patient Simulator

Unpack the Patient Simulator torso and legs following the instructions in reverse order of packing.

Daily Maintenance

The following preventive measures are required to ensure longevity of the SimMan Essential Patient Simulator:

IV Arm

When the day's sessions are done, flush the IV Arm with air to remove any fluid/liquid in the system. Connect a syringe filled with air to the IV catheter, and flush the IV arm with air until only air exits the overflow tube.

Fluid System

After each session where the fluid system has been used, drain the internal fluid reservoir. See *Empty Internal Fluid Reservoir* section.

Power off the Patient Simulator and PCs

Charge batteries if necessary.

Clean the Skin

Wipe the skin with a moist cloth to remove stains. Remove wet clothes or linens. Glue residue from the wound module tapes may be removed with Manikin Wipes.

General Clean-up

- Return Patient Simulator and PCs to original state

Single Use Modules

Based on the use of the Patient Simulator, replace modules that are spent or damaged:

- Cricothyrotomy: Crico-tape and Neck Skin
- Chest drain module pleura

Multiple Use Modules

- Fluid filter
- Pneumothorax bladders
- IO Modules (tibia)
- Chest Rise Bladders
- Lung Bladders
- Patient Simulator skins (body, legs, arms)

Before Storage or Shipping

IV Arm

Flush the IV Arm system with Isopropanol 60%-70%, and then flush with air. See *Regular Cleaning of IV Arm* section.

Fluid System

Before storage, the simulator's Fluid Systems should be flushed with Isopropanol 60%-70%, and then leave to dry to remove any Isopropanol residue from the system.

Follow the procedure *Regular Cleaning the Fluid System*.

 *Note: Do not store or ship the simulator with Isopropanol or liquid in any of the fluid/liquid systems.*

Detach the Patient Simulator's legs from the torso and pack into the transport cases as illustrated in *Transporting SimMan Essential*.

Regular Cleaning of Fluid System

Regular cleaning of the Fluid System is recommended as part of proper care of the product. Once or twice a month, the Fluid System should be cleaned thoroughly.

 *Note: For additional maintenance information related to the Fluid System, see Daily Maintenance.*

 *Note: During the cleaning procedure – Tank empty warning - may occur in LLEAP Software. This message can be disregarded during the cleaning procedure.*

Fluid System

To clean the Fluid System follow these steps:

Empty the system of water

- 1 Ensure that the simulator's power is ON.
- 2 Ensure that the simulator's internal fluid reservoir is drained. See: *Empty Internal Fluid Reservoir*.
- 3 Press the fill button located on the fill panel. The LED indicator on the fill button will light up.
- 4 Connect an empty fill bottle to the fluid and air connector in the fill panel, and the filling of air into the internal reservoir will start.
- 5 Insert Urine Catheter.
- 6 Wait until there are no more fluids emitted from the simulator; then remove Urine Catheter.
- 7 Disconnect the empty fill bottle.

Flush the system with isopropanol

- 8 Connect a fill bottle with Isopropanol 60%-70% to the fluid and air connector in the fill panel, and the filling of isopropanol into the internal reservoir will start.
- 9 Insert Urine Catheter.
- 10 Wait until isopropanol is emitted from all the fluid outlets.
- 11 When the system is flushed with isopropanol, press fill the

button again to deactivate the filling of isopropanol to the reservoir. The LED indicator on the fill button will now be off.

- 12 Leave the isopropanol fill bottle connected for approx. 30 seconds to let the internal reservoir drain completely.
- 13 Remove Urine Catheter and disconnect the fill bottle.

Empty the system of isopropanol

- 14 Connect an empty fill bottle to the fill panel and repeat steps 3-7 above to get the isopropanol out of the fluid system, using air.
- 15 Press the fill button once again so that filling is disabled (LED indicator should be off) and disconnect the empty fill bottle.

 *Note: Never store the simulator with isopropanol or liquid in the Fluid System.*

Regular Cleaning of IV Arm

Regular cleaning of the IV Arm system is recommended as part of proper care of the product. Once or twice a month, the IV Arm system should be cleaned thoroughly.

 *Note: Do not use force if the IV Fluid System seems blocked; it is likely that the simulator is not turned on.*

- 1 Ensure that the simulator's power is ON, and that the IV Arm is properly connected, see *Attaching the Right Arm* section.
- 2 Connect a syringe filled with Isopropanol 60%-70% to the IV Catheter. Press the prime switch, and flush the IV Arm system with Isopropanol. Release the prime switch when done.
- 3 Connect a syringe filled with air to the IV Catheter. Press the prime switch, and flush the IV Arm system until only air exits the drain tube. Release the prime switch when done.

 *Note: Never store the simulator with Isopropanol or liquid in the IV Arm system.*

Installing and Upgrading LLEAP

The Laerdal simulator Software comes preinstalled. When updating LLEAP, check also if updates for Patient Monitor, SimDesigner and SessionViewer/SimView are available. All available Software must be updated at the same occasion. Install or update the Software in the following order:

- 1 Update the Software on the instructor PC. See *Instructor PC and Patient Monitor PC* section.
- 2 Update the Software on the Patient Monitor PC. See *Instructor PC and Patient Monitor PC* section.
- 3 Update the Software on the Patient Simulator. See *Simulator Firmware & Network Fixer* section.

Instructor PC and Patient Monitor PC

- 1 Power on your simulator computers and ensure no simulator applications are running.
- 2 Visit www.laerdal.com/downloads to download the latest version of LLEAP and/or Laerdal Patient Monitor installers. Execute the file after it has been downloaded. Follow the on-screen instructions to complete the installation.

 *Note: It is recommended that simulator software on all your computers are updated at the same time to ensure continued compatibility after the update.*

 *Note: The LLEAP installer also includes Session Viewer and SimDesigner.*

 *The LLEAP and Patient Monitor applications will offer to download and install new versions if started while connected to Internet*

Simulator Firmware & Network Wizard

The update process of the software inside the simulator is handled by the Simulator Firmware & Network Wizard application. To update the Patient Simulator Software, follow the instructions in Simulator Firmware & Network Wizard Help.

 *Caution: Do not switch OFF the Patient Simulator while updating the Patient Simulator Software.*

Removing/Changing Router

The router may be changed or removed. Turn off the Patient Simulator before doing so.

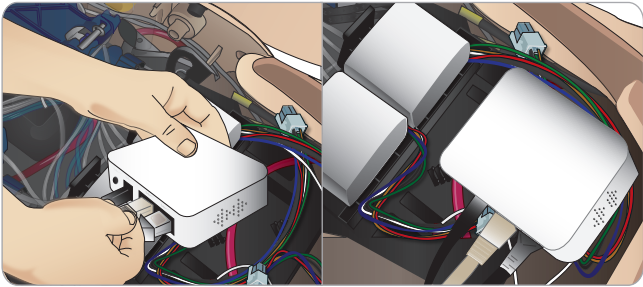

Open the pelvis and locate the router. Remove the two Ethernet cables and black power cable.

If you would like to operate the Patient Simulator without a router, then attach a through-adapter between the two Ethernet cables.

If you would like to install a new router, attach the power cable to the DC plug and the Ethernet cables back into the router again.

Opening the Torso

Open the Patient Simulator torso for the following procedures:

Attaching or Replacing Limbs

- Attaching or dismantling the Patient Simulator legs and arms.
- Exchanging default arms for optional IV or trauma arms.

Maintenance Tasks

- Changing the Patient Simulator batteries.
- Replacing the Pneumothorax Bladders, Chest-Rise Bladders, Lung Bladders, IO Modules and Chest Drain Modules.
- Replacing the Torso Skin.
- Performing a general inspection.
- Removing WLAN adapter.

To open the Torso Skin

- 1 Unzip the zippers on the Patient Simulator's left shoulder and torso.

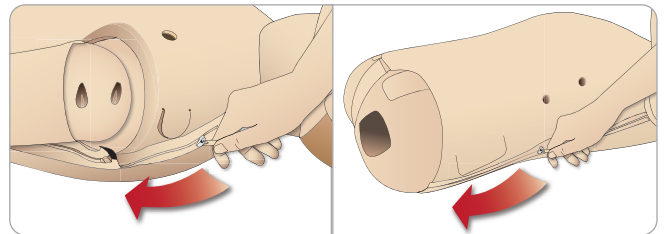

- 2 Remove the Genitalia Module and release the skin flap from the pelvis.

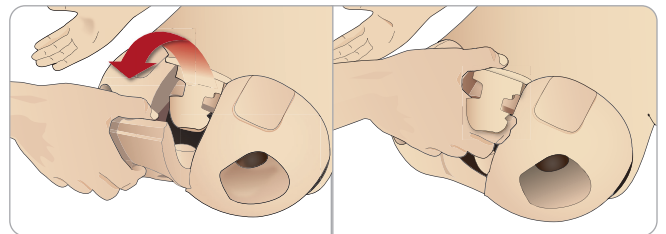

- 3 Fold the Torso Skin over to one side.

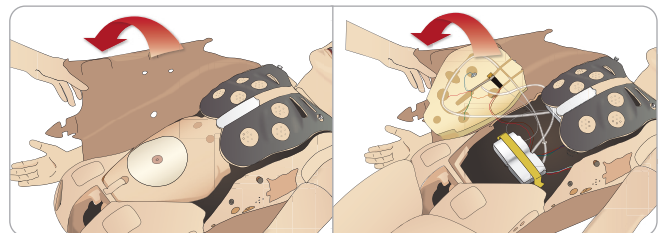

- 4 Open the Stomach Foam to one side, taking care not to tug on the connecting tubes and cables.

Note: DO NOT disconnect the tubes and cables connecting the Stomach Foam to the Patient Simulator.

- 5 Replace the Stomach Foam and close the Torso Skin, perform steps 1- 4 in reverse.

Attaching the Left Leg

Note: Assemble the Patient Simulator on a large flat surface. Attach the Left Leg before the Right Leg.

Open the torso to access the hip joint connectors. To open the torso follow steps 1 – 4, *Opening the Torso*.

- 1 Align the left leg bolt and cables with the pelvis socket.

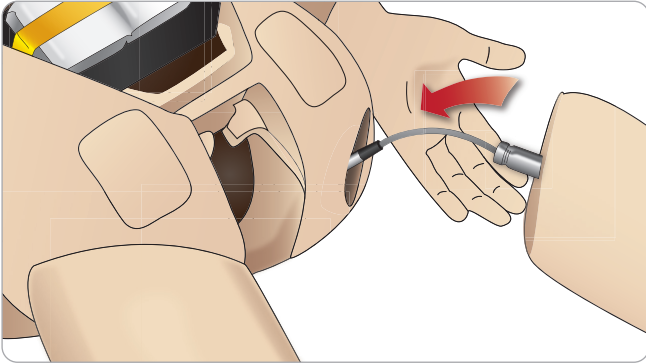

- 2 Feed the leg bolt and cable through the socket and into the torso. Do not pull the leg by the cables and/or tubes.
- 3 Carefully push the leg in towards the pelvis to form a snug fit.

Hip joint connector with side slot for inserting cables and tubes (shown right)

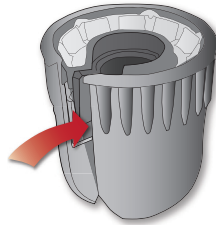

- 4 Position the connector with rounded end facing downward. Place the leg cables and tubes into the side slot of the connector.
- 5 Slide the connector downwards along the tubes and cable and onto the leg bolt. Ensure that the nut and bolt are aligned, and that all cables and tubes are secured within the connector.
- 6 Screw the connector onto the leg bolt. Avoid twisting the cable. Tighten the connector so that the leg is able to rotate freely around the hip joint connector.

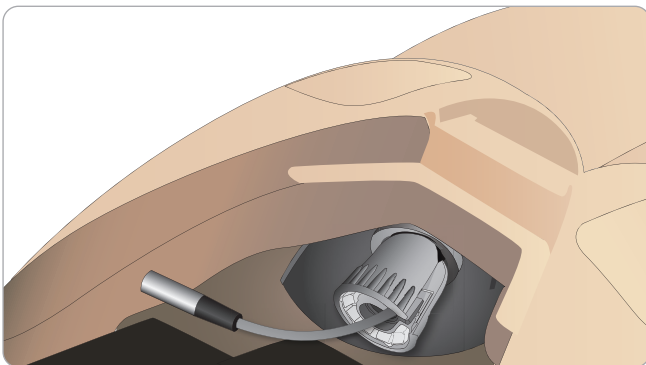

- 7 Connect the cable as shown in the following page.

Left Leg to Pelvis – Cable and Tube Descriptions

Name/Label	Tube/Cable Color	Connector Description
Left Pedal	Grey cable	black with silver coloured connector

Attaching the Right Leg

Please take the same precautions as when attaching the Left Leg.

- 1 Align the Right Leg bolt and cables with the pelvis socket. Feed the leg bolt and cabling through the pelvis socket.

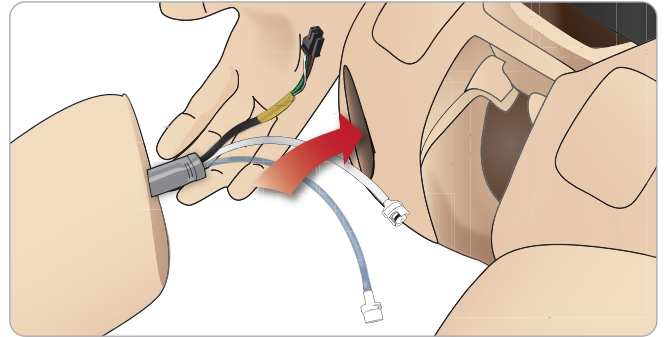

- 2 Carefully push the leg in towards the pelvis to form a snug fit.
- 3 Secure the cables and tubes in the connector. Screw the connector in place on the leg bolt.

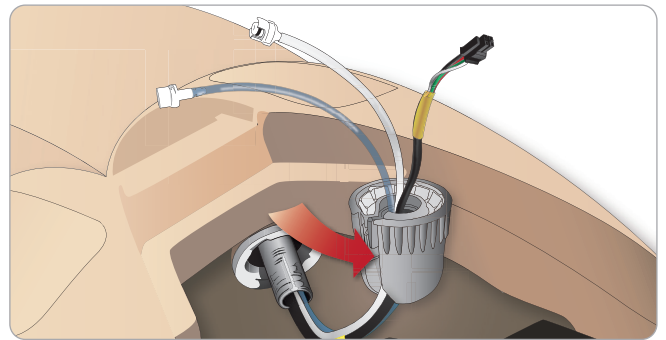

- 4 Connect the corresponding tubes and cables as shown in the table below:

Right Leg to Pelvis – Cable and Tube Descriptions

Name/Label	Tube/Cable Color	Connector Description
Blood Right leg	Transparent, red tube	Black twist and lock connector
Right leg	Black harness cable	Black rectangular connector, 4 lead
Air from leg	Colourless transparent tube	White twist and lock connector
Fluid from leg	Tube, blue	White twist and lock connector

Attaching the Left Arm

Open the torso as described in steps 1 - 4, *Opening the Torso*. Follow the procedures listed below in reverse to detach the arms.

- 1 Align the left arm axle with the shoulder socket.

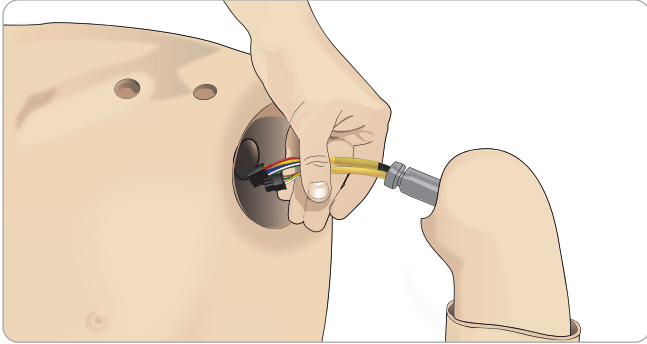

- 2 Ensure that the shoulder screw is loose enough to allow the arm axle to slide easily into place.
- 3 Feed the cables from the arm axle through the shoulder socket.
- 4 Carefully push the arm axle into the shoulder bracket, so that the axle is flush with the inside of the bracket.
- 5 Tighten the shoulder screw with the Allen wrench.

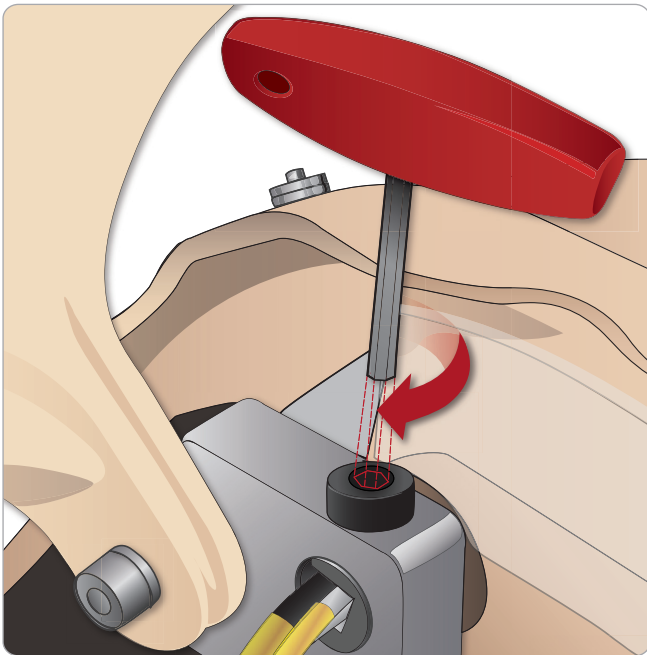

- 6 Connect the arm cables to the corresponding connection points in the torso.

Left Arm to Torso – Cable and Tube Descriptions

Name/Label	Tube/Cable Color	Connector Description
LA Pulses	Grey cable	Black rectangular connector, 6 lead
BP	Grey cable	Black rectangular connector, 2 lead

Attaching the Right Arm

Open the torso as described in steps 1 - 4, *Opening the Torso*. Follow the procedures listed below in reverse to detach the arms.

- 1 Align the arm axle with the shoulder socket.

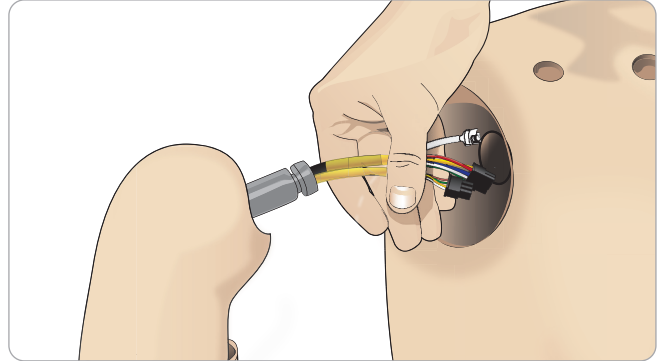

- 2 Feed the cables from the arm axle through the shoulder socket.
- 3 Push the axle into the bracket until it is flush with the inside of the bracket.
- 4 Tighten the shoulder screw with the Allen wrench.

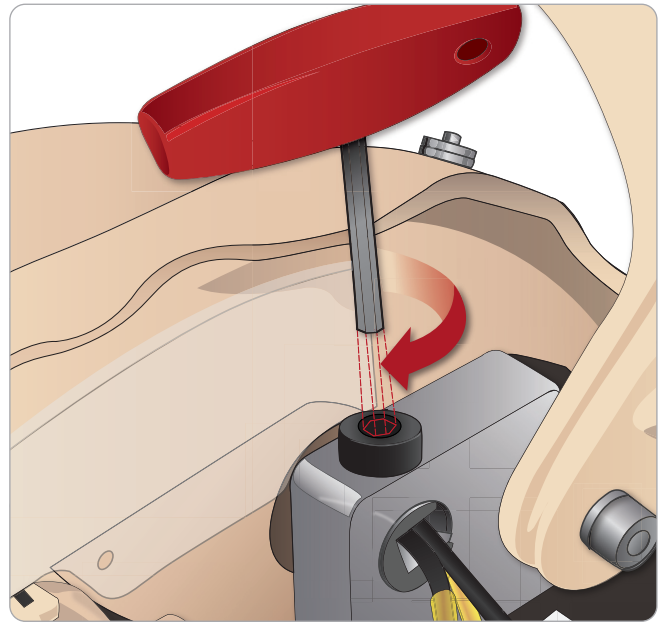

- 5 Connect the corresponding cables as shown below.

Right Arm to Torso – Cable and Tube Descriptions

Name/Label	Tube/Cable Color	Connector Description
Right Arm	Black harness cable	Black rectangular connector, 4 lead
Air	Transparent Tube	White tube twist connector
Right Radial	Grey harness cable	Black with silver colored connector

Replacing Crico Tape/Neck Skin

After creating an emergency airway through the cricothyroid membrane, replace the perforated membrane before starting a new simulation session.

- 1 Remove the neck skin (hook and loop fasteners behind the neck).

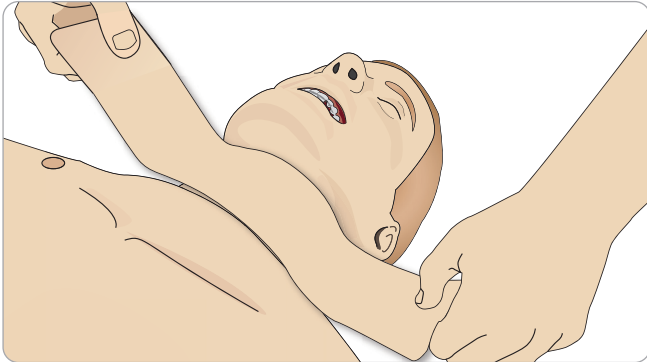

- 2 Remove the old strip of Crico Tape.
- 3 Replace with a new Crico Tape.

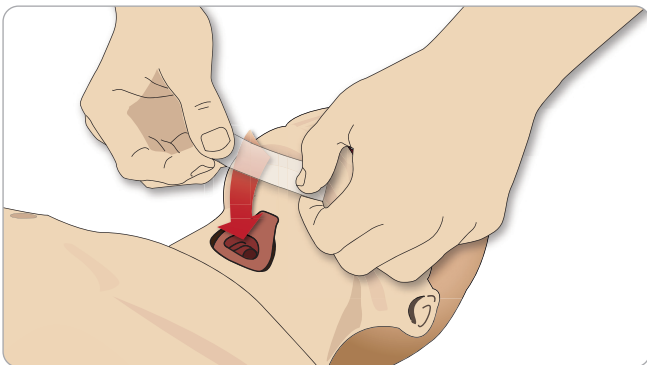

- 4 Ensure Crico Tape completely covers and seals the opening to prevent leakage while ventilating the Patient Simulator.

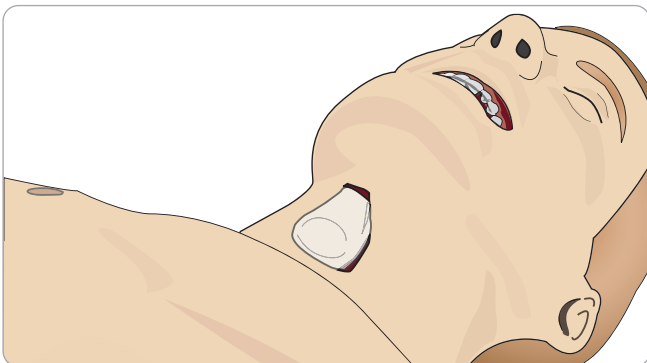

Replacing Chest Drain Pleura

The Chest Drain Module's pleura skin should be replaced after each use.

- 1 Open the Torso Skin and remove the module from the chest.

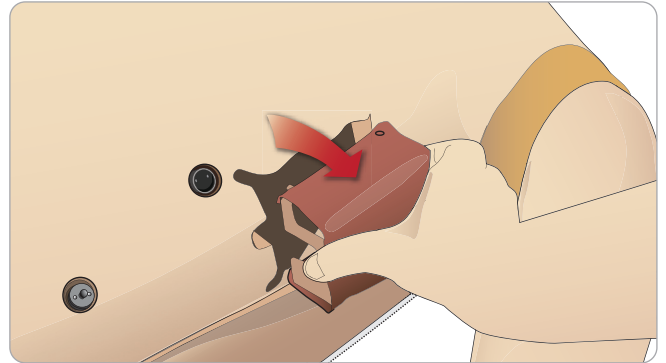

- 2 Remove the old pleura skin, and replace with a new skin and replace the module.

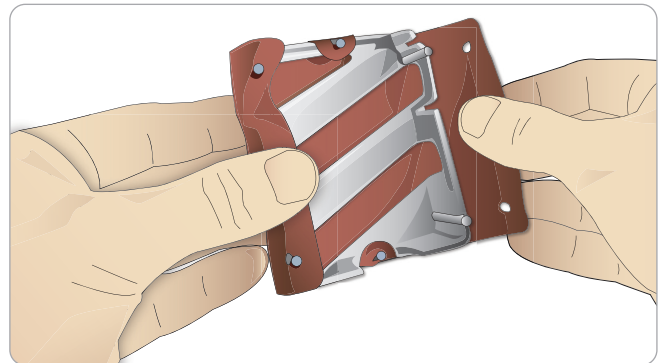

Replacing Pneumothorax Bladders

After multiple pneumothorax decompressions, the bladders may need replacement:

- 1 Open the Torso Skin to expose the chest plate. Lift the Chest Plate to reveal the Pneumothorax Bladders located in slots in the side of the Chest Plate assembly.
- 2 Slide out the used Pneumothorax Bladder.
- 3 Disconnect the tube and discard the old bladder:

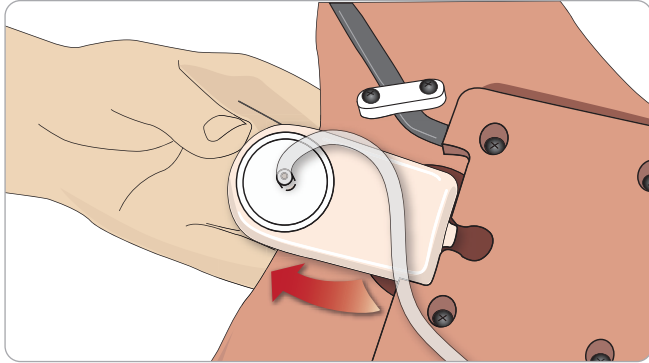
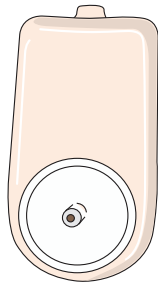

- 4 Insert the new bladder into the slot.
- 5 Reconnect the tube to the new bladder.

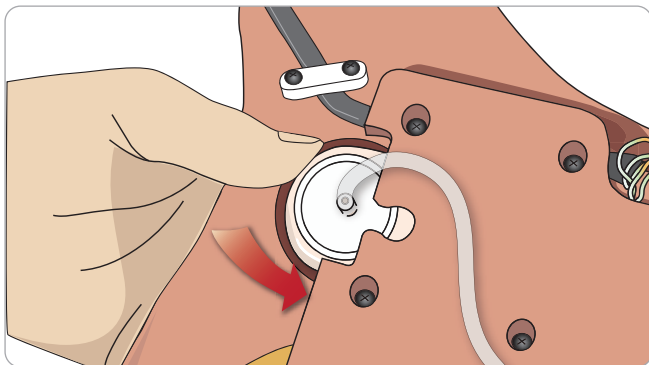

Replacing Chest Rise Bladder

If the Chest Rise Bladders leak or are damaged:

- 1 Open the Torso Skin to expose the Chest Plate. There is one bladder on each side of the Chest Plate assembly.
- 2 Disconnect the tube from the bladder:

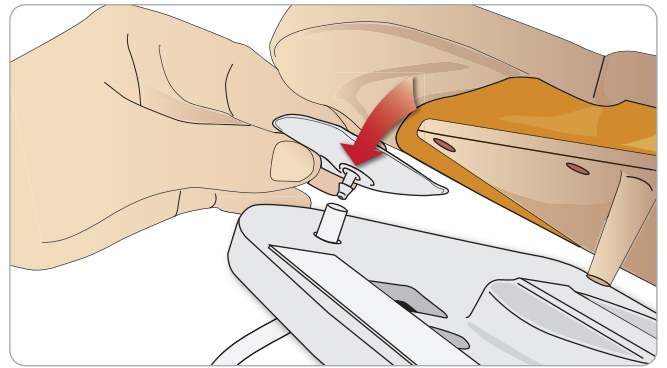
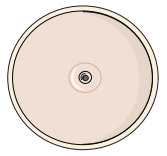

- 3 Discard the used bladder.
- 4 Insert new bladder.
- 5 Reconnect the tube to the new bladder.

Left Leg to Pelvis – Tube Descriptions

Name/Label	Tube Color	Connector Description
Pneum L	Silicon	Barb connector
Pneum R	Silicon	Barb connector
Chest L	Silicon	Barb connector
Chest R	Silicon	Barb connector

Replacing Lung Bladders

If leaking occurs, the Lung Bladders (in the chest cavity) should be replaced.



- 1 Open the Torso Skin and put the Stomach Foam to the side.
- 2 Open the hinged Chest Plate upwards, to access the lungs.

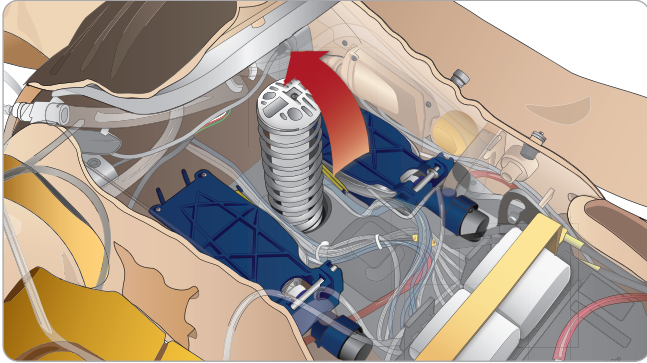

- 3 Remove the chest compression spring for easier access to the lungs.

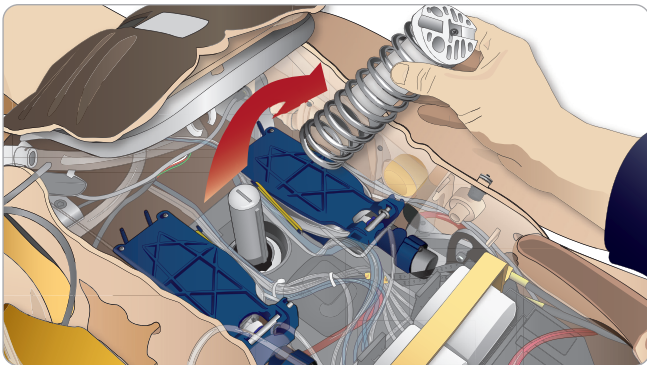

- 4 Unhook the yellow lung compliance bands from each side of the lung assembly.

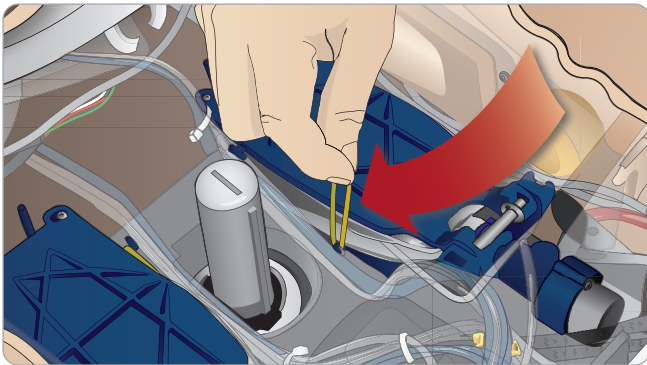

- 5 Open the hinged lung plate.
- 6 Pull the old lung out from its socket.

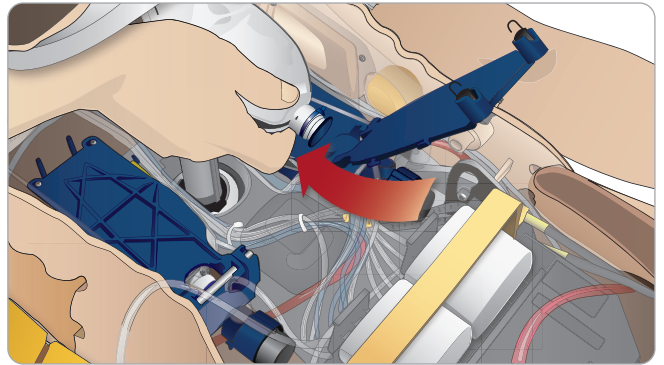

- 7 Reverse this process to insert a new lung.

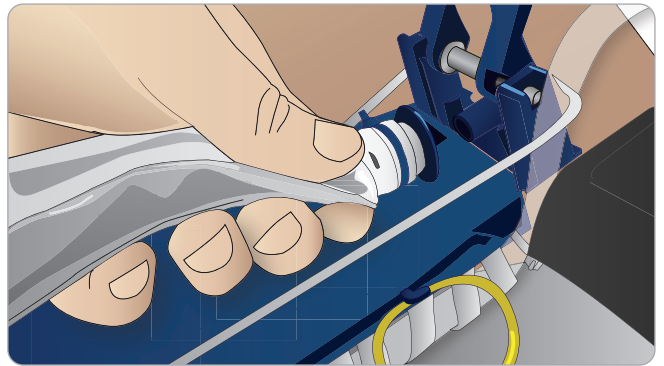

Note: Ensure that the compliance bands intersect between the two folds of the lung.

Replacing Simulator Skins

The simulator skins may need to be replaced if they become torn, perforated, or stained.

- 1 Unzip and unroll the skin.

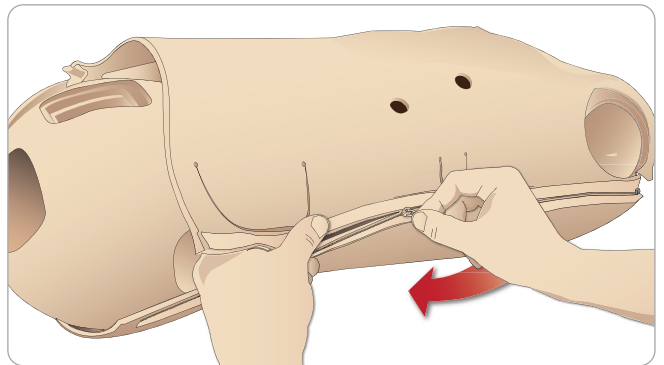

- 2 Applying powder to the inside of arm, torso and leg skins will help reduce friction and make replacing the skins easier.

To prevent the zippers from separating from the skin, make sure to properly position the skin halves and hold them together while zipping them closed.

Servicing the Patient Simulator

A full service, including cleaning of the base board, should be performed at regular intervals.

 *Caution: All servicing must be performed by qualified service personnel.*

Always perform a service:

- If liquids have been spilled in the Patient Simulator
- After use in dusty environments.

 *Caution: Do not use cables or connectors showing visible damage.*

Troubleshooting

System Setup

Problem

- Lost data or total system failure (General System failure).

Solution

- Should system shut down or all data is lost or corrupted; please contact your local Laerdal Service Center.

Stability And Connection In Access Point Mode (Ap) (Patient Simulator Created Network)

Problem

- Connection between LLEAP and/or Patient Monitor and Patient Simulator is lost.

Causes

- Other Software on PCs may interfere with LLEAP or Patient Monitor.
- Multiple network connections may interfere with transmissions between our Software and Patient Simulator.

Possible Solutions

- Remove unnecessary Software on PCs.
- Disable other networks.

Stability And Connection In Client Mode

Problem

- Connection between LLEAP and Patient Monitor and Patient Simulator is lost.

Causes

- Patient Simulator has been positioned where limited connectivity to external network exists.
- Other Software on PCs may interfere with LLEAP and/or Patient Monitor.

Possible solutions

- Move Patient Simulator to improve connectivity to external network.
- Remove unnecessary Software on PCs.

LLEAP

Problem

- Unable to log on to the computer.

Causes

- If the user decides to change the log on behavior it will require a password.

Solutions

- Default password is "SimUser".

Changing Patient Simulator Wireless

Network Display name

If operating more than one Patient Simulator; ensure that each simulator has its own unique SSID name. For more information see Simulator Firmware & Network Fixer Help.

Voice Conference Application

Problem

- Sound from Patient Simulator to LLEAP is not working.

Possible Solutions

- Check that the microphone has not slipped out of place. Open the head skin zipper, located at the back of the head, enough to reveal the ears.
- Ensure that the microphone is positioned in the cup located towards the top of the ear with the black surface facing outwards.

Problem

- Instructor microphone not picking up sound.

Possible Solutions

- Unplug and re-plug the headset to your computer
- Ensure correct sound device is selected. In Voice Conference Application main menu, select <Options>, <Select Device>.
- Check volume settings in Windows. Ensure microphone is not muted.

Debriefing

See section Troubleshooting in SimView User Guide or SessionViewer User Guide.

Patient Simulator

Problem

- Unpredictable behavior

Possible Solutions

- Patient Simulator malfunctions may be caused by loose cables, tubes or connectors. Open the torso and check if any items appear to have become disconnected or are leaking. See *Opening the Torso*.
- In case of fluid leakage, power off the Patient Simulator and contact Laerdal Technical Service.

Problem

- Identifying a single Patient Simulator when there are multiple simulators on a network?

Solutions

- When checking the Patient Simulator's pulse, the <Select Simulator> dialog of LLEAP will indicate which Patient Simulator is pulse palpated.

Airway contamination

Problem

- Simulator airways have become contaminated from mouth-to-mouth rescue breathing.

Solution

- Clean the outside of the Patient Simulator with Manikin Wipes. Clean the inside of the oral cavity with Manikin Wipes. Change the Lung Bladders; see: *Maintenance - Replacing Lung Bladders*.

 Note: The Patient Simulator airways are not designed for mouth to mouth rescue breathing or to be disinfected.

Chest movement

Problem

- No chest rise on Patient Simulator:

Solution

- Check that Patient Simulator is switched ON.
- Check that Patient Simulator is not in sleep mode due to inactivity. Reactivate the Patient Simulator.
- Check that awRR is not set to zero in LLEAP (Patient Case or scenario)
- Check that airway complications like maximum air resistance or laryngospasm are not set.
- Check if the internal compressor is switched off. See: *Turning the Internal Compressor Off/On*.
- Check that any external compressed air source is switched off and that the air tube is disconnected from the Patient Simulator.
- The internal compressor may have overheated. Wait approximately 20 minutes for it to cool down. Remove blankets or covers from the Patient Simulator; open the Torso Skin to facilitate cooling.
- Chest-rise is set to bilateral (for example if ET-tube is inserted too far into the bronchia).
- Chest-rise bladder is leaking or tubing to Chest Rise Bladder is twisted, kinked or disconnected. Replace Chest Rise Bladder if it is leaking, see *Maintenance: Replacing Chest Rise Bladders*.
- Check air tubing for leakage; check that all connections are intact. Replacing tubing if necessary.
- Shallow chest movements and the internal compressor runs continuously. The internal compressor may be worn - contact Laerdal Technical Service.

Simulator Limbs

Problems

- Lack of motion in the legs.

Possible Solution

- Loosen and re-adjust the hip joint nuts on the inside of the pelvis. See *Maintenance* for details on how to attach the legs

Lungs

Problem

- Lungs not functioning properly.

Possible Solution

- Check that the airway resistance is not set to maximum in LLEAP.
- Open the torso and chest plate. Check that the lungs are free to expand and are not restricted by any cables.
- Check that the lung bladders are properly connected, and that the tubes are not twisted.
- Check that the lung bladders are in a horizontal position and inserted correctly. Ensure that the lung compliance O-rings lie between the folds of the lung bladders.
- Check for flaws or ruptures in the lung bladders.
- Check that the two lung compliance O-rings are fitted correctly. Replace O-rings if they appear to be damaged.
- Check that there are no obstructions inside the simulator airways which may block air flow.
- If there is no change when adjusting lung compliance, contact Laerdal Technical Service.
- If there is no change in lung resistance, contact Laerdal Technical Service.

Mechanical Noise during Auscultation

In LLEAP, click <auscultation focus>.

Batteries

Problem

- Battery life is less than 150 minutes with healthy patient and fully charged batteries.

Possible Solutions

- Batteries may be old, (recommended lifetime is 200 discharge cycles). Insert new batteries.
- Compressor may not function properly; consult your local Laerdal Technical Services Centre.

Pulses

Problem

- Cannot feel pedal pulses.

Possible Solutions

- Skin may be too tight over pulse units – readjust skin and reboot.

Clinical Features - Pneumothorax Bladders

Problem

- Experience problems with Pneumothorax Bladders.

Solution

- Check tubing connection at base of the bladder, to ensure that tubing has not been disconnected.

Simulator Shut down

Problem

- The Patient Simulator is unresponsive.

Solution

Press and hold the <ON/OFF> button for 10 seconds to force the Patient Simulator to shut down.

Troubleshooting the IV Arm

Problem

- Veins do not energize.

Solution:

- Ensure Patient Simulator is powered on and IV Arm cable and air tube are connected to the Patient Simulator.
- Ensure the blood reservoir is filled, see Filling and priming the system.
- Ensure the tourniquet area is activated (depressed).
- Look for a leak between the IV Arm pad and the IV Arm chassis.
- If the tourniquet area has been activated several times within a short period of time, internal pressure in the IV Arm may drop. Wait 30 seconds to let pressure rebuild and try again.

Problem

- When injecting more than 40ml fluid and prime switch is depressed, no fluid is visible in the drain tube.

Solution

- Leak inside IV Arm. Contact Laerdal Technical Service.

Problem

- After releasing the prime switch and filling the internal reservoir, more than 16ml of fluid can be injected into the arm.

Solution

- Leak inside the IV Arm. Contact Laerdal Technical service

Problem

- There is a leak between IV Arm Pad and IV Arm chassis.

Solution

- Ensure the IV Arm Pad is fully inserted and secure in the IV Arm chassis.
- If this does not help, too high pressure has been applied to the IV Arm Pad during the filling process. Replace the IV Arm Pad.

Problem

- No flashback when inserting Intravenous Catheter into IV Arm Pad

Solution

- Ensure that the collection bag is at the same elevation as the IV Arm.

Spare Parts and Accessories

For latest version of Spare Parts and Accessories, visit www.laerdal.com

© 2016 Laerdal Medical AS. All rights reserved.
Manufacturer: Laerdal Medical AS
P.O. Box 377, Tanke Svilandsgate 30, 4002 Stavanger, Norway
T: (+47) 51 51 17 00

20-07893 Rev E

www.laerdal.com

