

Premature Anne Task Trainer

User Guide



American Academy
of Pediatrics



DEDICATED TO THE HEALTH OF ALL CHILDREN™







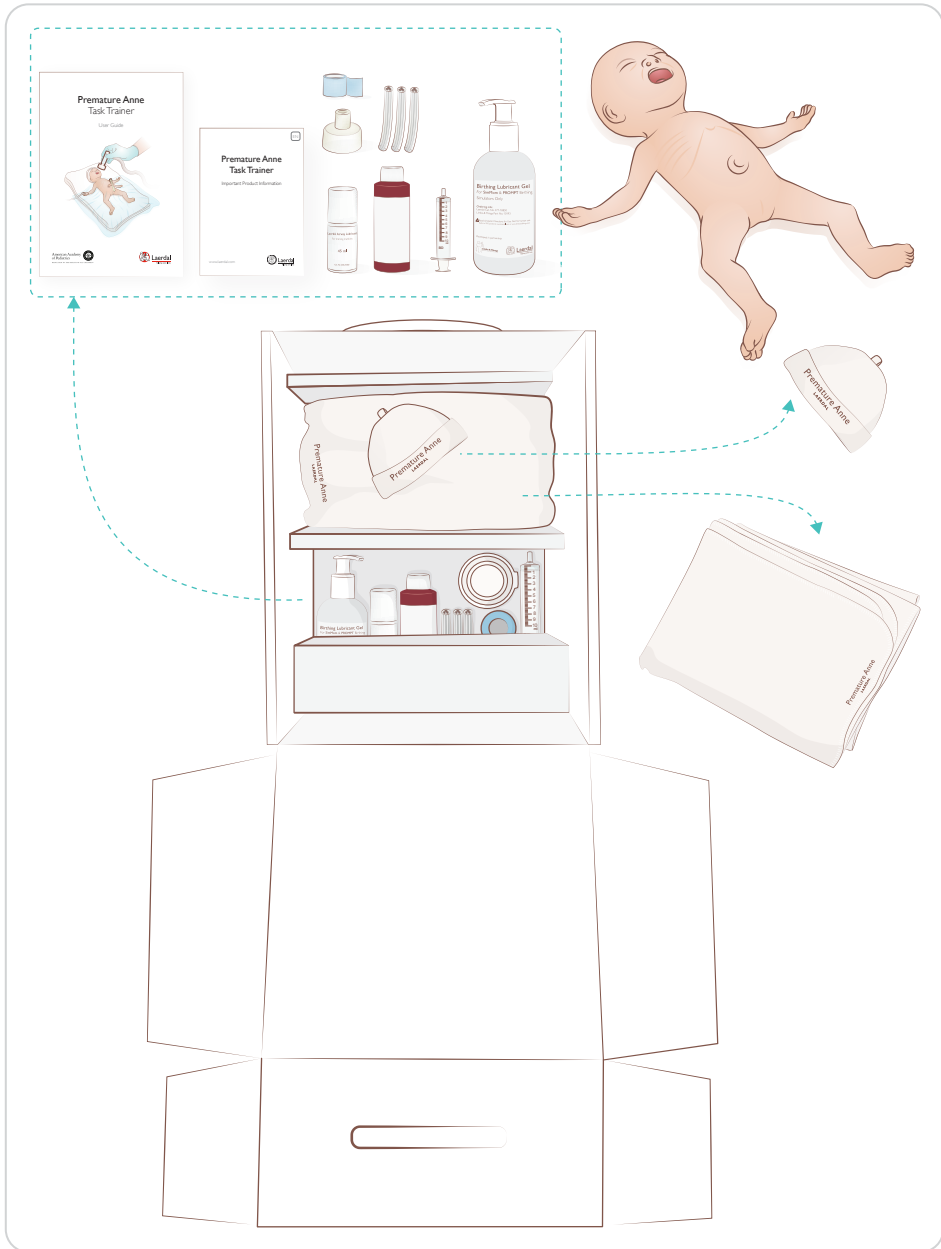





Laerdal

helping save lives



Important Product Information

	4
	5
	6
	8
	9
	10
	14
	16
	19
	22

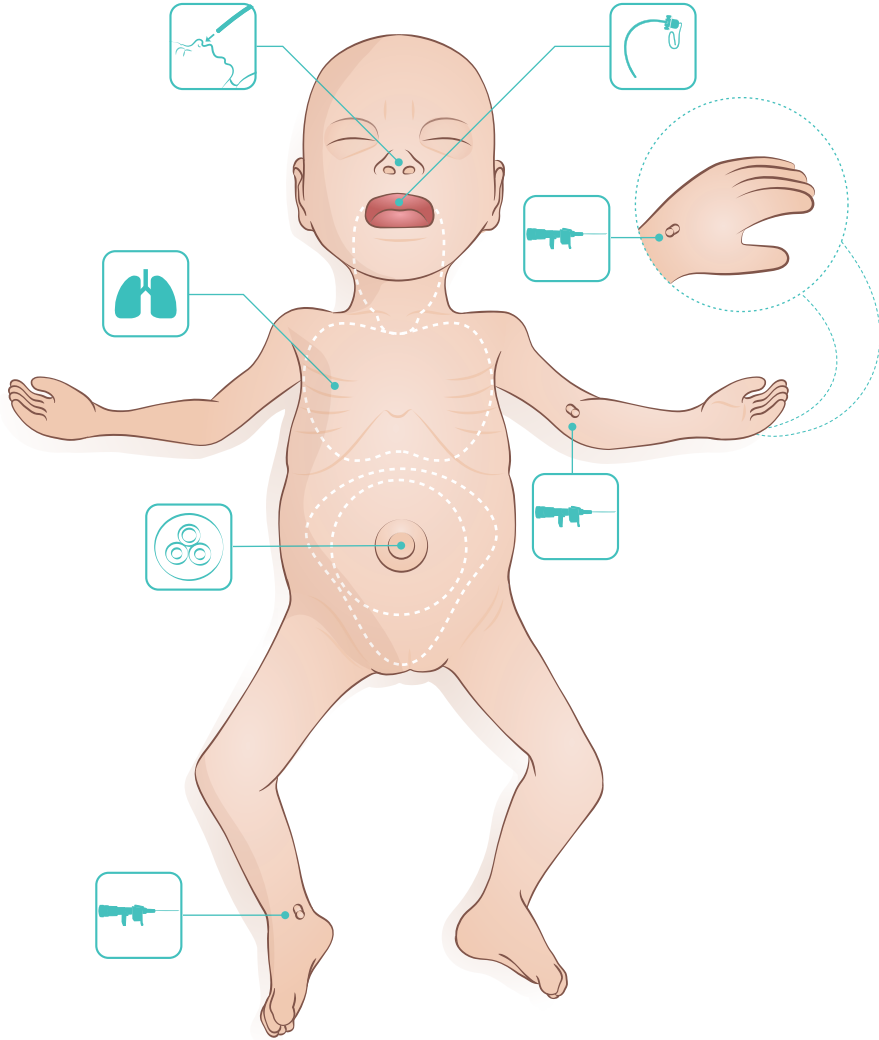

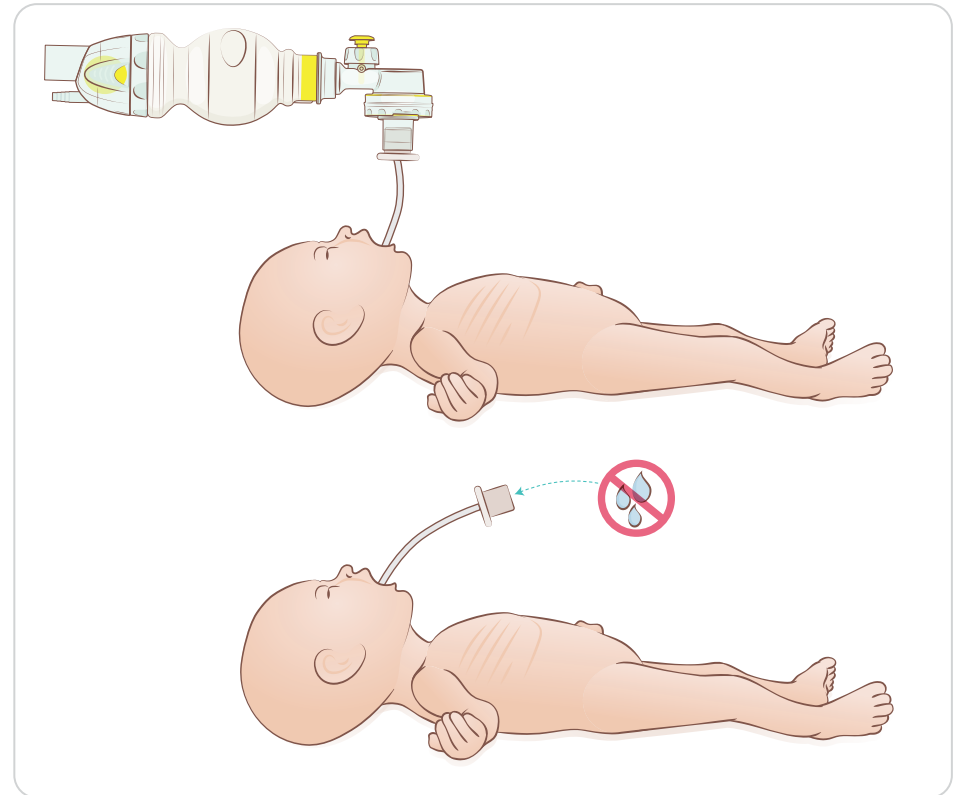
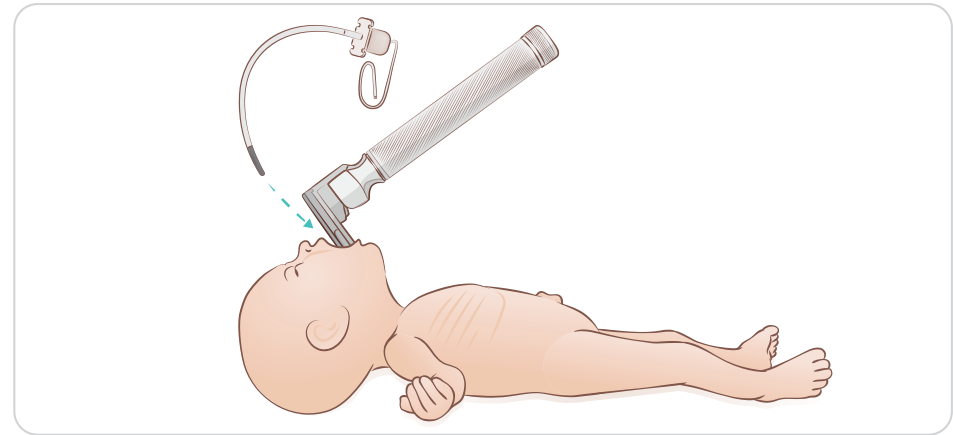
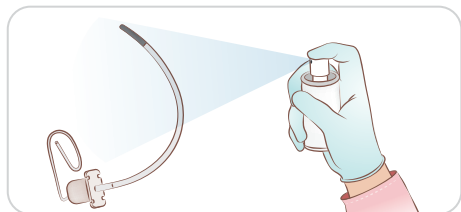
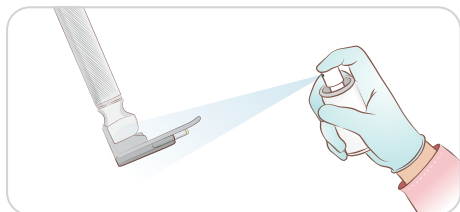
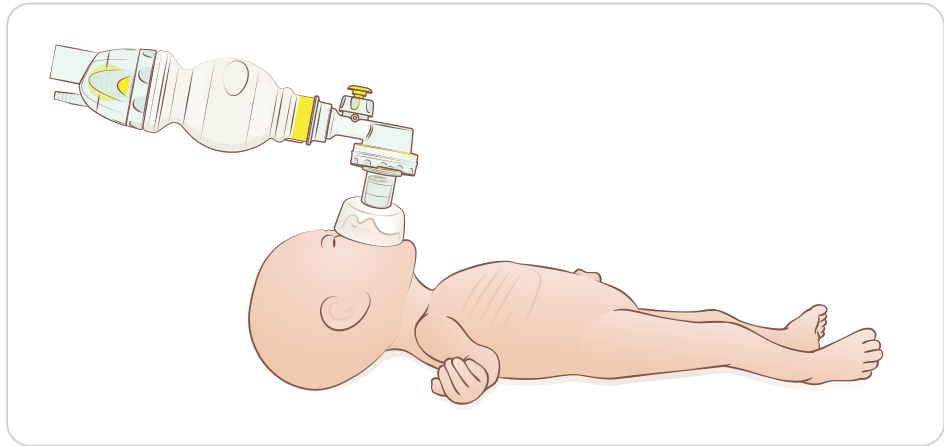
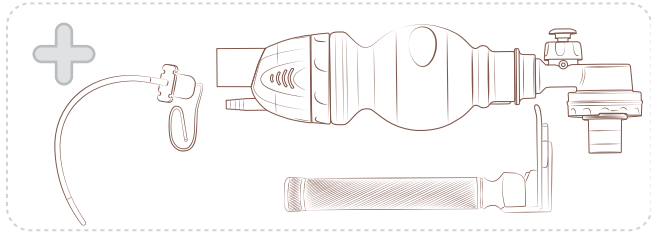

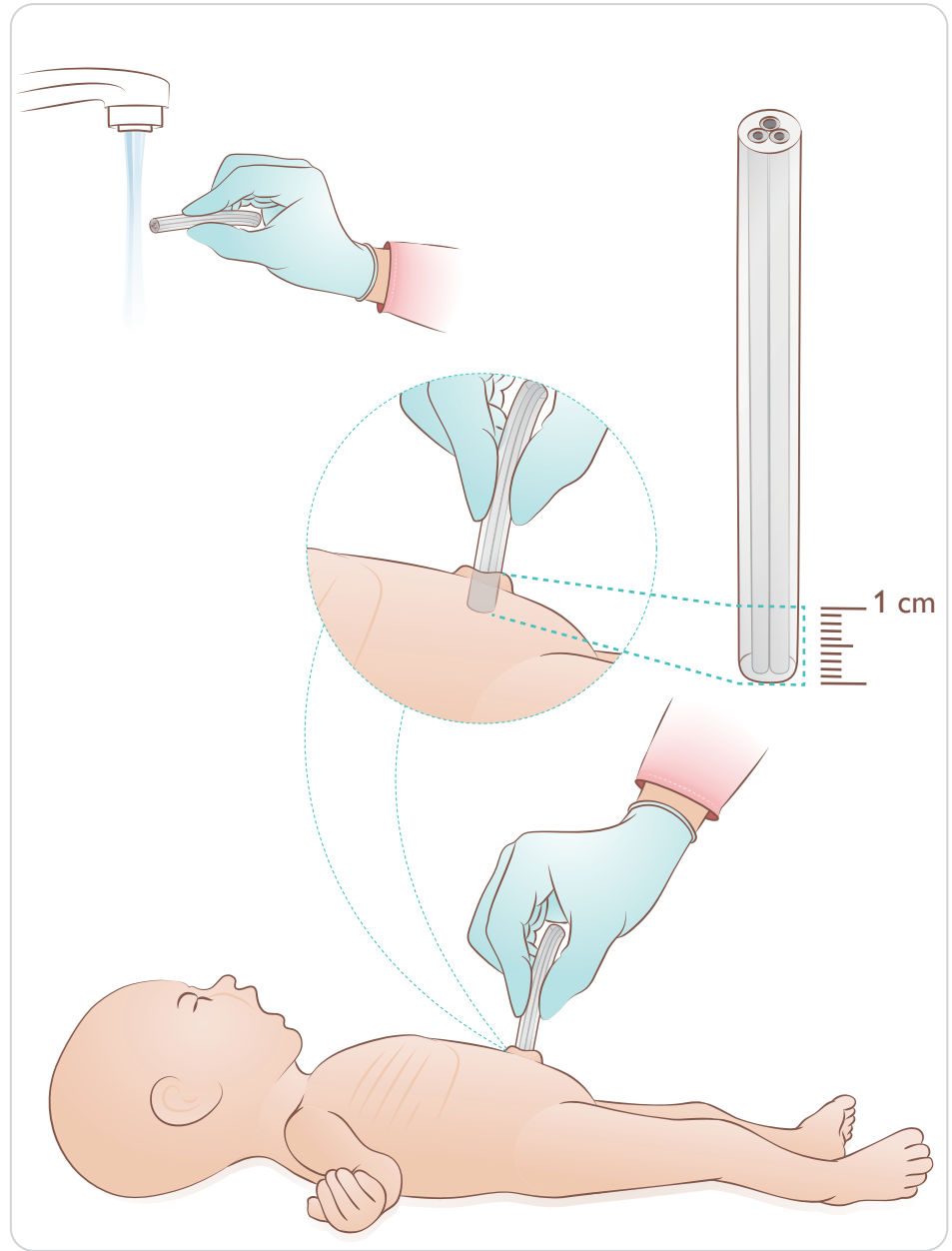
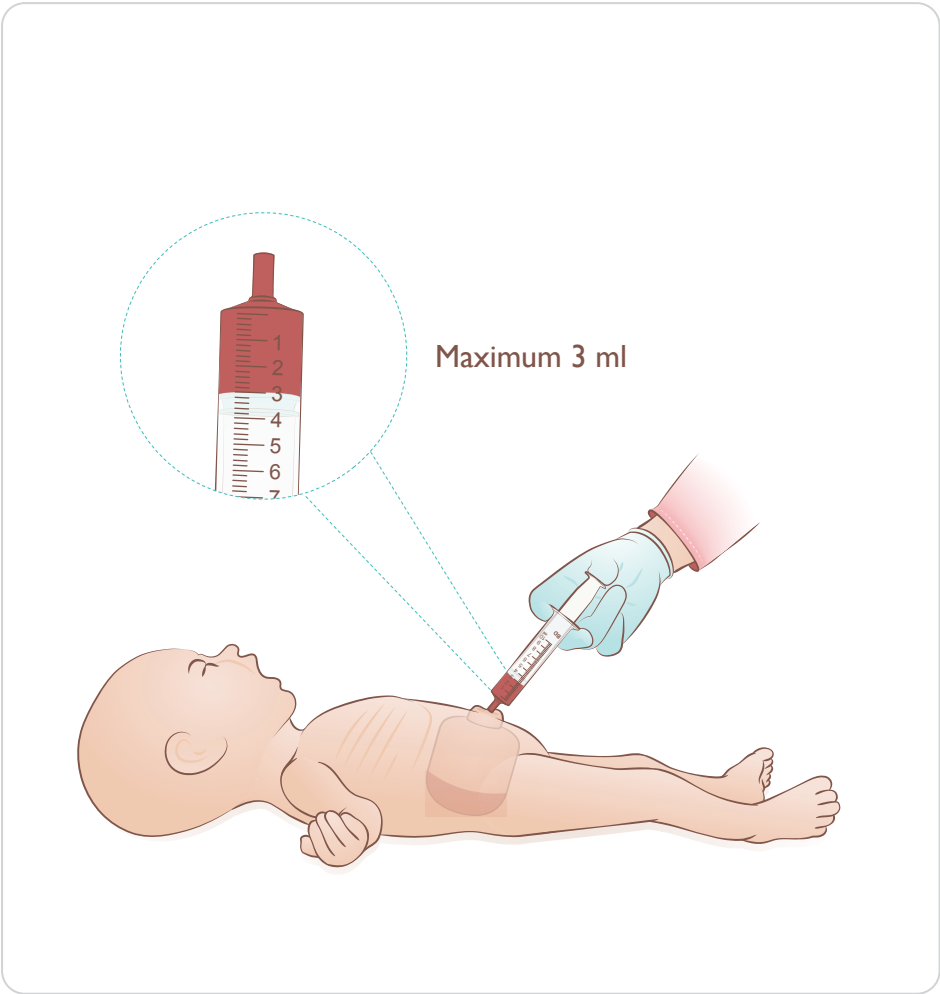
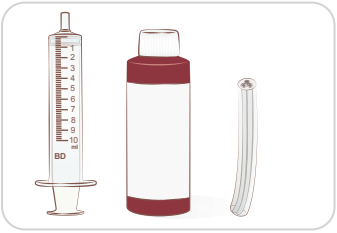

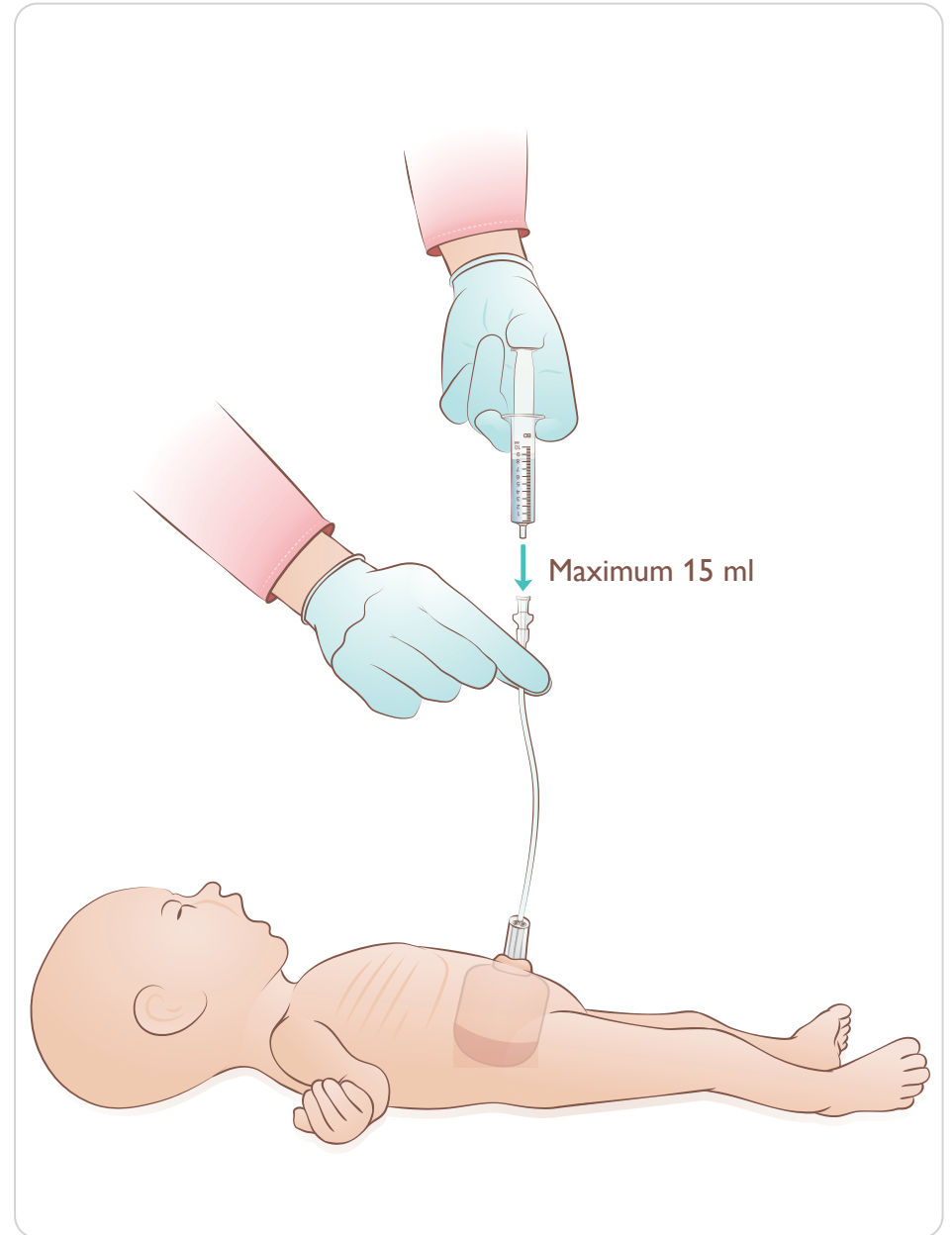
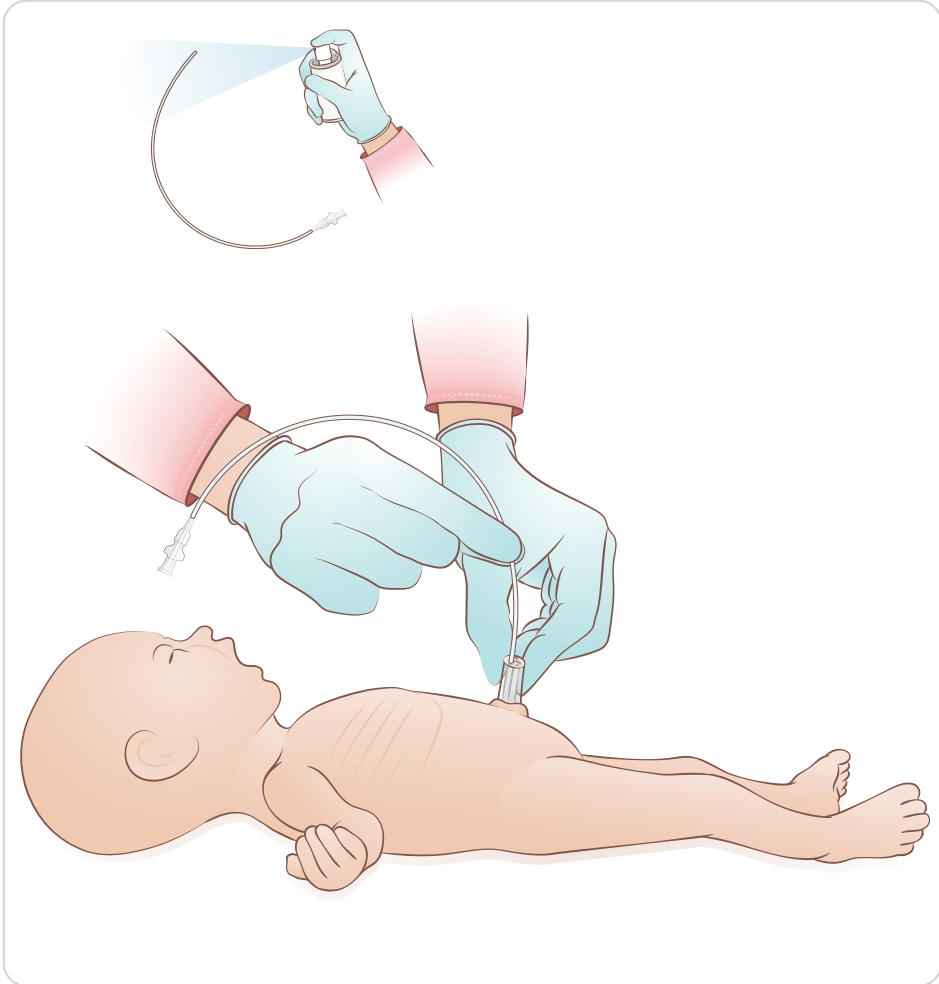
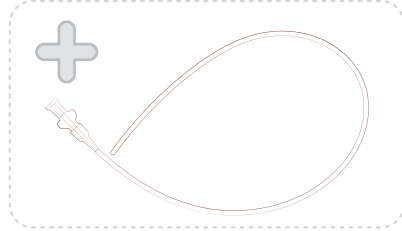
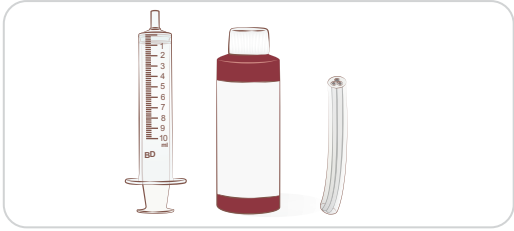

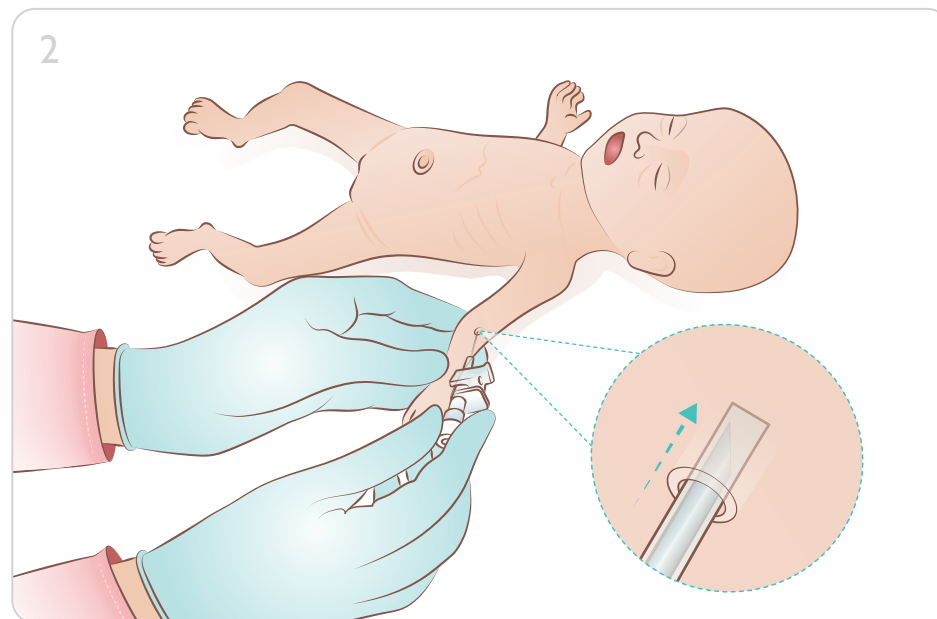
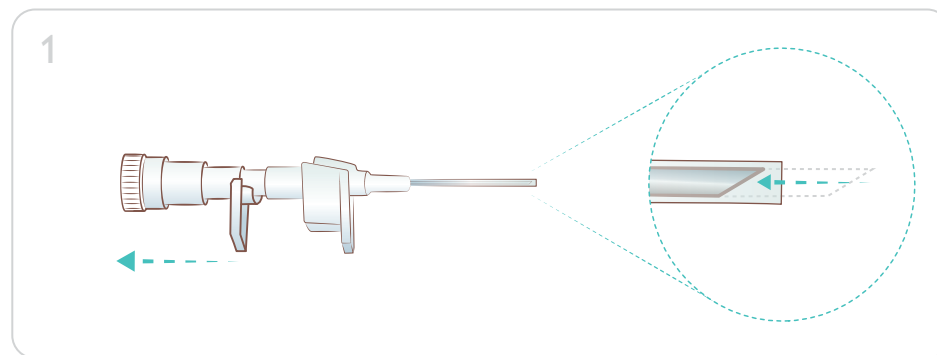
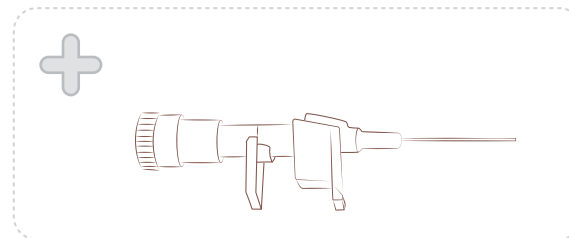
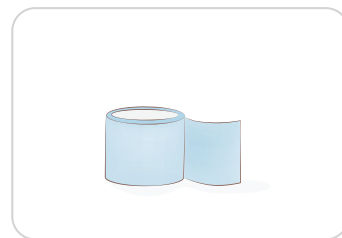
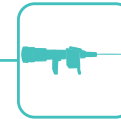
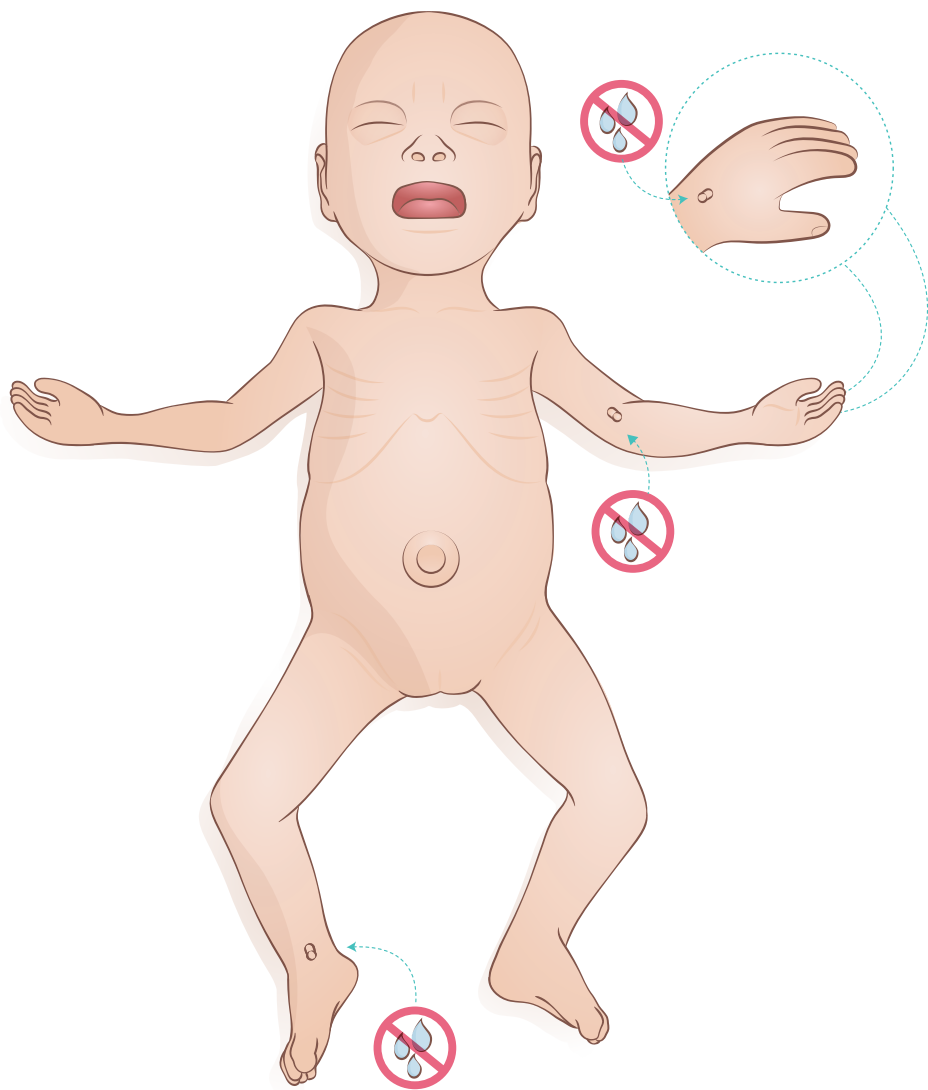

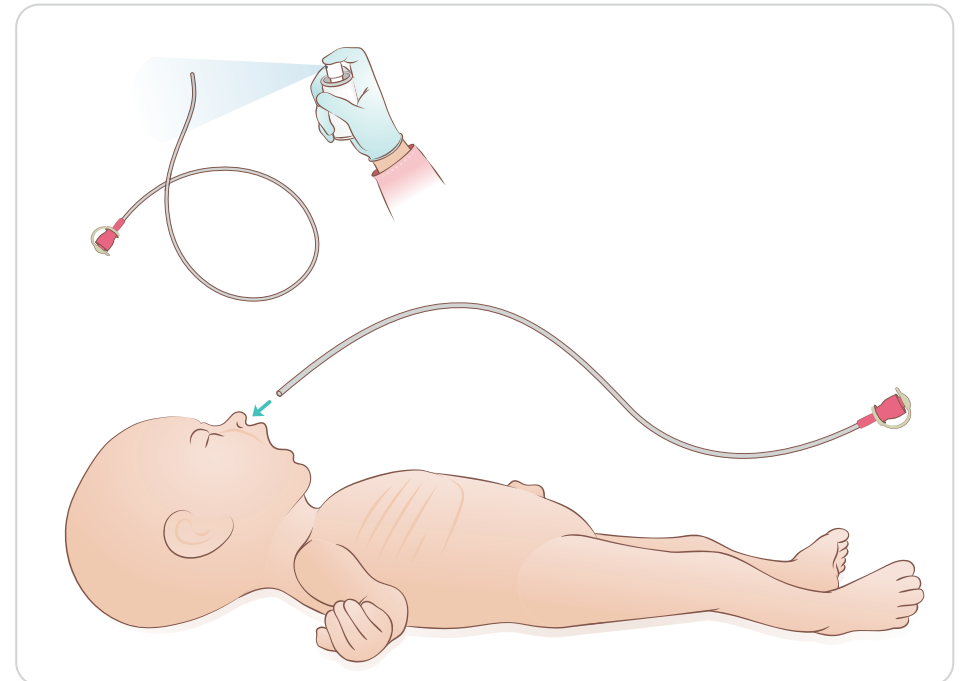
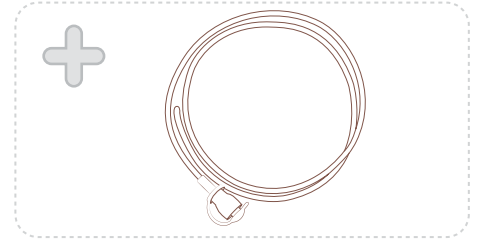
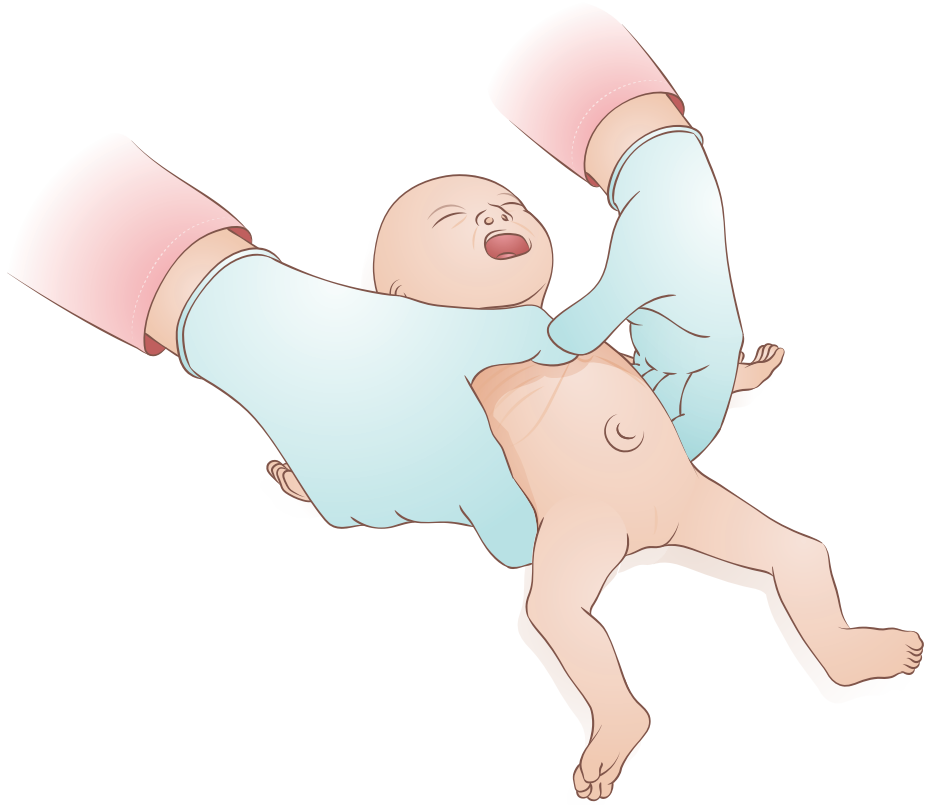

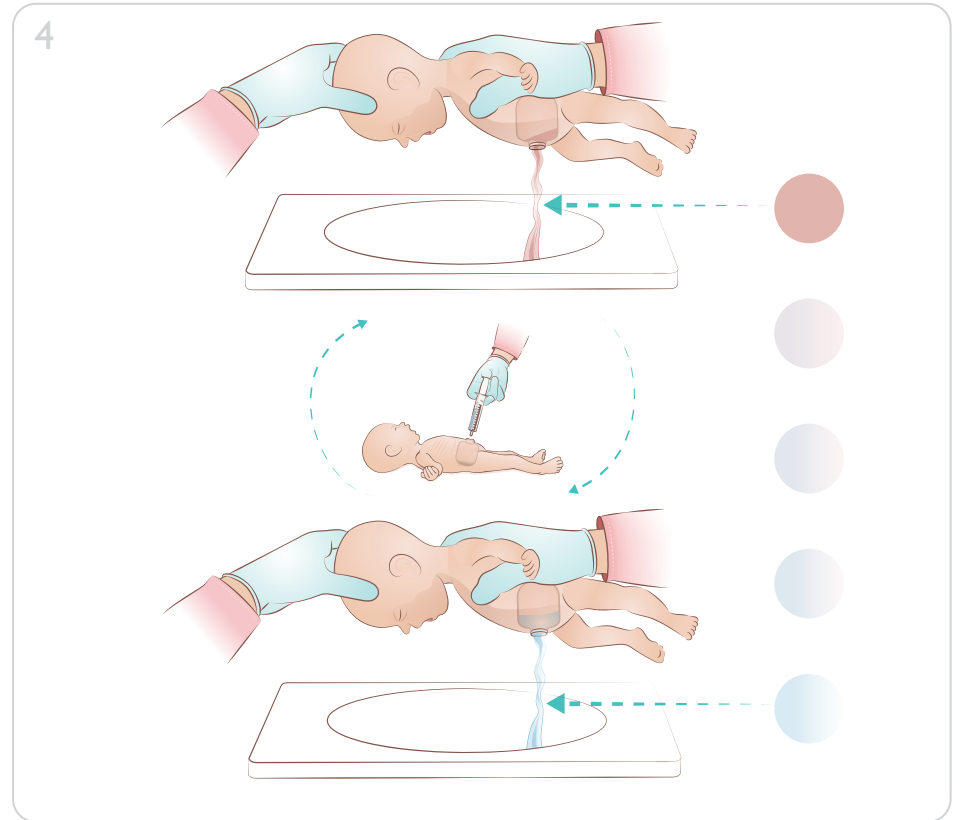
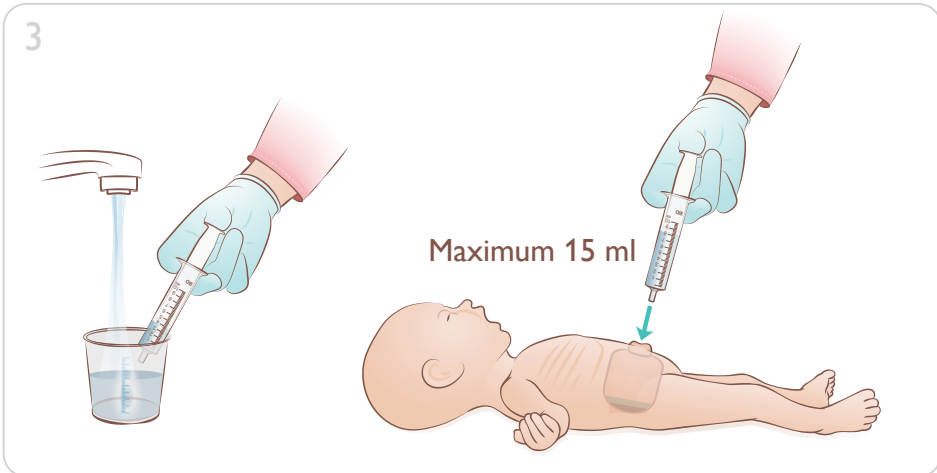
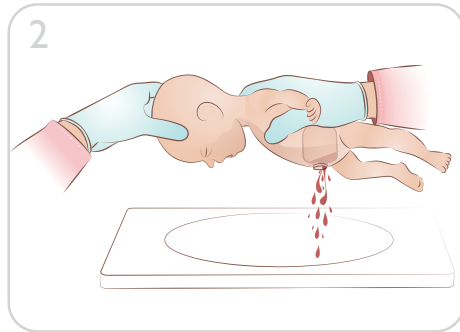
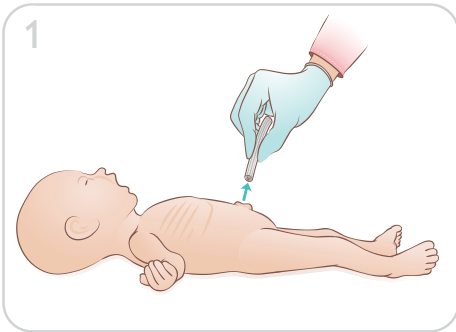
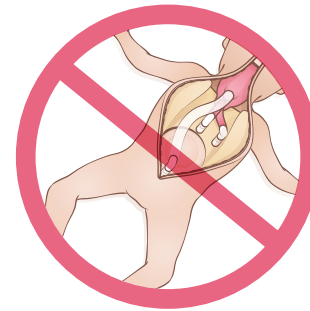
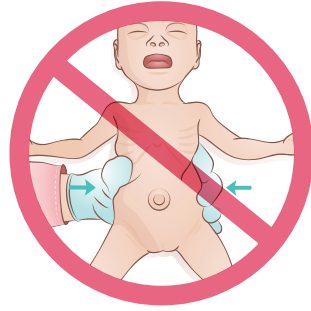

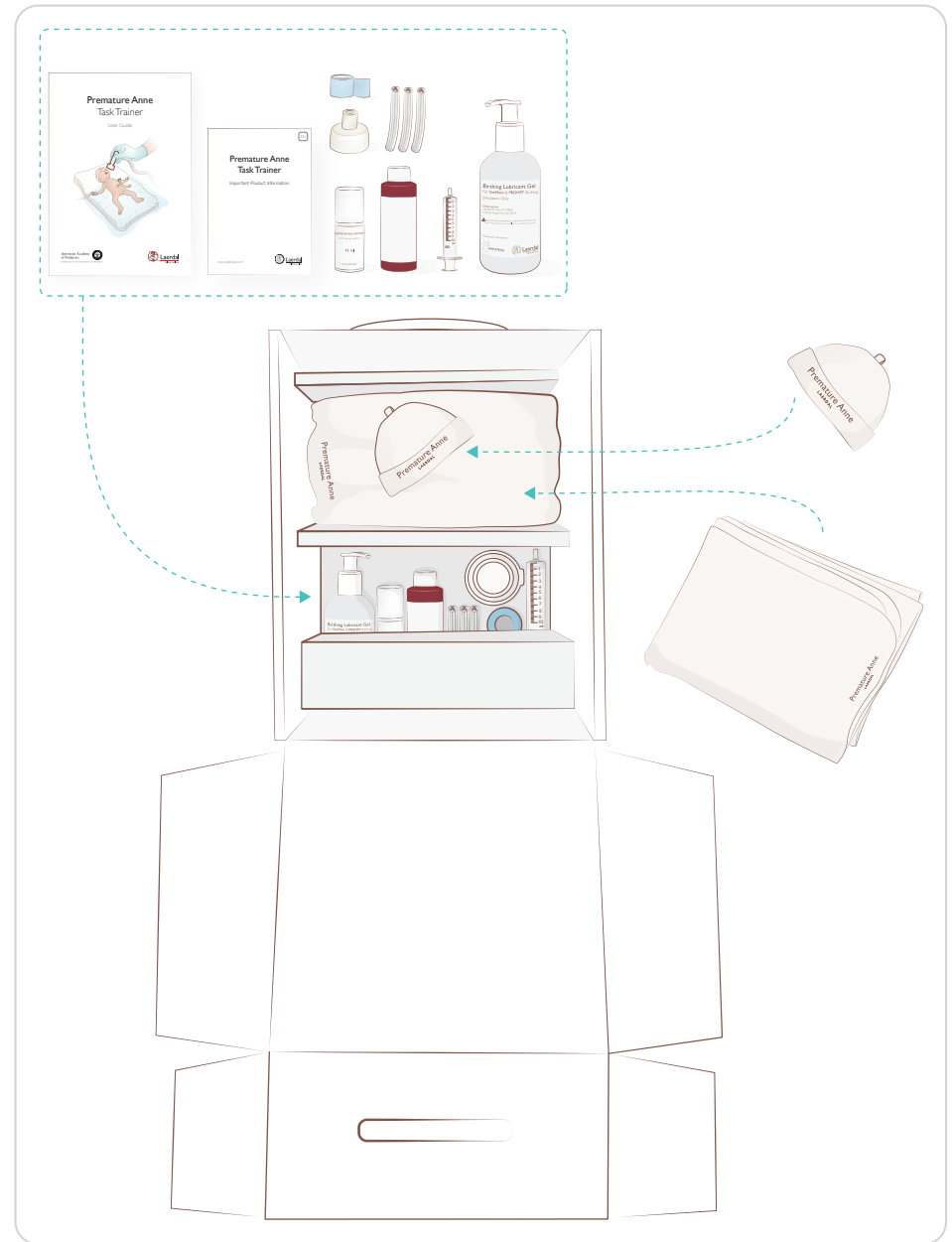

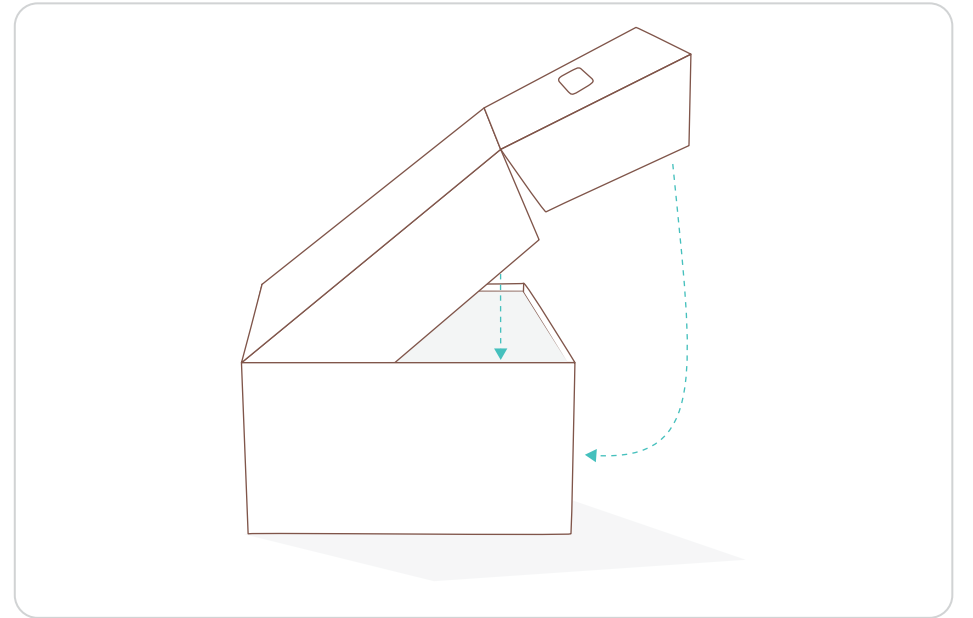
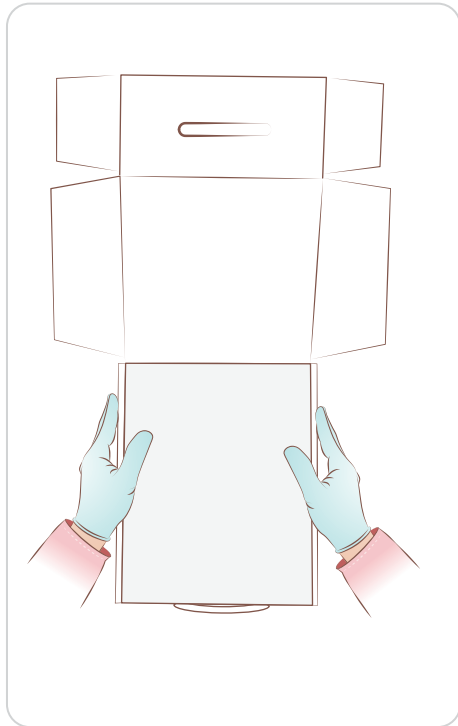
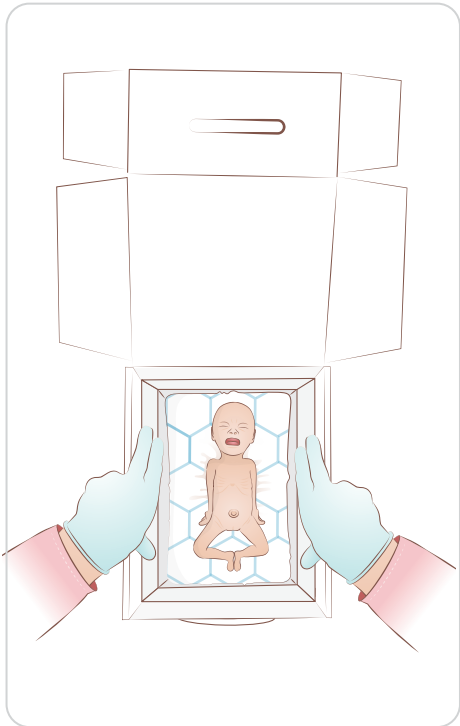
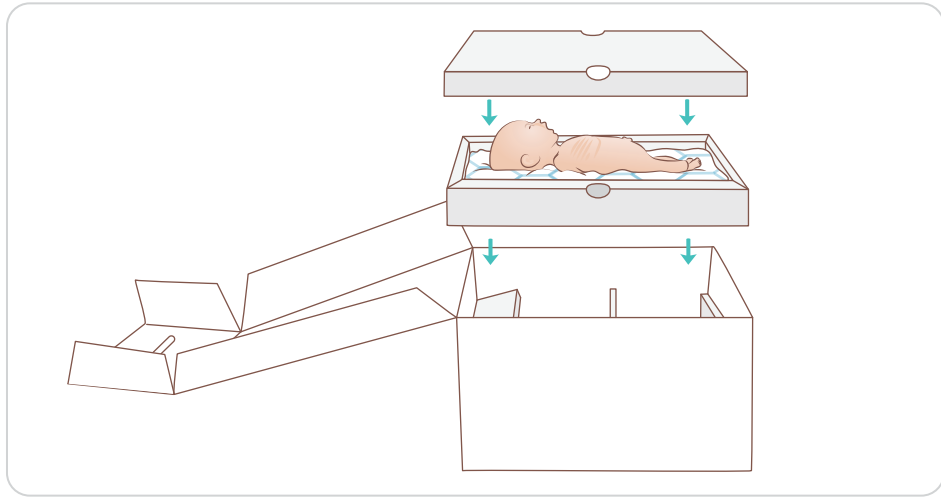





Equipment		Size
	Laryngoscope	Miller 0 / 00
	ET Tube	2.5 mm (oral and nasal)
	Peripheral IV Sites	24 G
	NG/OG tube	6 – 6.5 Fr
	Umbilical Catheter	3.5 Fr Arterial 5 Fr Venous
	Facemask	42 mm

© 2015 Laerdal Medical AS. All rights reserved.

Printed in Norway

20-09627 Rev B

American Academy
of Pediatrics



DEDICATED TO THE HEALTH OF ALL CHILDREN™



Laerdal

helping save lives